

DORAN

Model 4300

Model 7400

Model 7000XL

Model 8000XL

Excel Series

INSTRUCTION MANUAL



DORAN SCALES, INC.
1315 PARAMOUNT PKWY.
BATAVIA, IL 60510
1-800-262-6844
FAX: (630) 879-0073
<http://www.doranscales.com>
MANUAL REVISION: 2.0
MAN0239 4/11/2007

Table of Contents

Table of Contents	3
Introduction	8
Scale Operation	10
Fig. 1: Model 7400 Front Panel Layout	10
Model 7400:	10
Fig. 3: Model 4300 Front Panel Layout	11
Model 4300:	11
Fig. 4: Model 7000XL Front Panel Layout.....	11
Model 7000XL:	12
Fig. 5: Model 8000XL Front Panel Layout.....	12
Model 8000XL:	12
Electrical Connections:.....	12
Power Up:	13
Basic Weighing Operation:.....	13
ZERO button:	13
UNITS button:(7400 optional).....	13
PRINT button:(7400 optional).....	14
4300 OVER / UNDER buttons:.....	14
Accumulator and Counter (Hidden button)	14
Battery Operation	16
Turn Off: (8000XL or Battery option)	16
Low Battery Indication: (8000XL or Battery option)	17
Checkweigh Operation	18
7400 Zero Band Checkweighing Operation:.....	18
4300 Over, Under and Accept Checkweighing Operation:.....	18
4300 Digital Entry and Recall of Over and Under Limits:	18
4300 Digital Entry of Over and Under Limits: (optional configuration).....	19
4300 Push-button Entry of Over and Under Limits: (optional configuration).....	19
4300 Five Band Checkweighing Operation: (optional configuration).....	19
4300 Digital Entry and Recall of High and Low Limits:	20
4300 Digital Entry of High and Low Limits: (optional configuration)	20
4300 Push-button Entry of High and Low Limits: (optional configuration)	21
Serial Entry and Recall of Limits:	21
Setpoint Operation	22
Digital Entry and Recall of Setpoint Limits:.....	22
4300 Digital Entry and Recall of Setpoint Limits:.....	22
Installation Guide	24
Fig. 6: Load Cell connections	24
Removing the Rear Panel	24
Replacing the Rear Panel	24
Load Cell and Power Connections:	25
RS232 and Remote Switch Connections:	25
Fig. 7: Serial, Remote SWITCH and power Connections	25
Calibration Guide	26
Entering Calibration and Parameter Setup Mode:.....	26

Capacity:	26
Resolution:	27
Calibration:	27
A/D Ranging:	29
Table 1: Calibration requirements in raw counts	29
Parameter Setup	30
Entering and Exiting the Calibration and Parameter Setup Mode:	30
Stepping through the menu parameters:	31
Changing a Parameter settings:	31
Parameter Review of Calibration and Setup Values:	32
Legal for Trade Restrictions:	32
Audit Counters:	32
Software part number and revision level:	32
Setup Parameters Explained.....	33
Capacity Setup Menu	34
Count By Setup Menu	34
Calibration Menu	34
Digital Filter Setup Menu	35
Automatic Zero Tracking Setup Menu	35
Motion Aperture Setup Menu	36
Start Up Zero Setup Menu	36
Latching Zero Request Setup Menu.....	36
Latching Print Request Setup Menu.....	36
Printer Data Output Setup Menu	37
Output Formats	37
Baud Rate Setup Menu	37
Serial Data Handshaking Setup Menu	38
Scale Address (Scale ID number)	38
Units Conversion Setup Menu.....	38
Start Up Units Selection Menu	39
Push-button Function Setup Menu	39
Operating mode Setup Menu	40
Unit On Timer (Battery option only)	40
Checkweighing Operation Menu	41
Setpoint & Checkweight Entry Menu	42
Threshold Level Menu.....	42
Checklimit Entry Mode Menu (4300 mode only)*	42
Over and Under Band Setup Menu (7400 mode only)	43
Default all Scale Parameter settings	43
ISP Mode.....	43
Test Mode Menu	44
Calibration and Parameter Menu Exit.....	44
Data Communications	45
Introduction to data communications:.....	45
Printer Modes:.....	46
Transmit on demand (TOD):	46
Continuous print (CP):.....	46
Auto Print 1 (AP1):	46
Auto Print 2 (AP2):	46

Auto Print 3 (RP3):	47
Data output format:.....	47
"F0" Format:	47
"2d" Format:	47
"55P" format:.....	47
"F9" Format:	47
"UP5" Format:	48
"d3" Format:	48
"161 - 164" Format:.....	48
Print String Formatting:	48
Label Buffer Configuration.....	53
Label Buffer Default settings	54
Remote Setpoint Entry and Recall:	54
Table 2: Doran serial protocol	56
Specifications and Interconnect Data.....	57
Specifications:	57
Table 3: Scale Specifications	57
Interconnect Data:.....	57
Table 4: TB1 Load Cell Connections.....	57
Table 5: P2 Options Connections.....	58
Fig. 10: RS232 Output DB9 Connector (optional)	58
Table 6: Serial Output pin description	58
Table 7: P3 Keyboard Connections.....	58
Table 8: J1 Power Connections	59
Fig. 11: Installation of EMI / RFI / ESD protection devices	59
Fig. 12: Jumpers and Connector Locations.....	60
Table 9: Board Jumper Settings.....	60
Fuse Replacement:	61
Table 10: Line Fuse Values.....	61
Fig. 13: F1 Fuse Holder.....	61
4-20mA Analog Output (optional).....	62
Introduction	62
Setup.....	62
Operation	62
Fig. 14.1: 4-20mA Analog Option Board.....	62
Fig. 14.2: Example of a Active 4-20mA circuit.....	63
Fig. 14.3: Example of a Passive 4-20mA circuit.....	63
Digital Output Board (optional).....	64
Fig. 15.1: Digital Output Board	64
Digital Output Board Specifications:.....	64
Fig. 15.2: Digital Output Board Installed.....	65
Fig. 15.3: Digital Output Board Jumper Locations	65
RS485 Communications (optional).....	66
Fig. 16.1: Digital Output Board with RS485 Option	67
RS485 SETUP	67
Table 11: RS485 Option Specification.....	68
Table 12: RS485 Termination Resistors.....	69
Fig. 16.2: RS485 two wire system	69
Internal Relay Option (optional).....	70

Fig. 17: Digital Output Board Wiring.....	70
Fig. 18: Internal Relay Board.....	70
Internal Relay Setup:.....	71
Relay Specifications:.....	71
Table 13: Internal Relay Output Cable Color Code	71
Step-up Relay Circuit:	72
Fig. 19: Example of a Step-up Relay circuit.	72
External Relay Box Option (optional)	73
Fig. 20: External Relay Box.....	73
Fig. 21: Knock-out Plugs	74
External Relay Setup:	74
Fig. 22: Mechanical Relay Module	74
Table 14: Scale Signal Cable Color Code.....	75
Digital Output Board Setup:.....	75
Fig. 23: Digital Output Board Wire and Jumper locations.....	75
Wired Ethernet Option (optional).....	76
Features and Applications:.....	76
Fig. 24: RJ-45 Ethernet connector.....	76
Specifications:	76
Doran Wired Ethernet Configuration Guide	77
Module LED Description.....	79
Wireless 802.11b Ethernet Option (optional)	80
Fig. 25: Wireless Ethernet Antenna.....	80
Features and Applications.....	80
Specifications:	81
Doran Wireless Ethernet Configuration Guide	82
Module LED Description.....	85
WPA – Pre-Shared Key.....	87
WPA – Authentication	87
Factory Configuration Data Sheet	87
Defaulting Wired and Wireless Ethernet Modules.....	88
Connecting to a scale through a web page	92
USB Option	93
Fig. 26: USB option board	93
USB Windows Drivers.....	93
Installation For Windows XP:.....	93
Removal For Windows XP:	96
Installation For Windows 2000:	98
Removal For Windows 2000:	102
Dimension Software.....	104
Description:	104
Fig. 27: Dimension Software Live Scale Window	104
Live Scale Configuration:	104
Troubleshooting	105
General problem resolution:	105
Scale Messages:.....	106
Error Messages:.....	106
Resetting the scale parameters:.....	107

Resetting the scale:.....	107
UPS Application Note	108
Description:	108
Hardware Setup:	108
Software Setup:.....	108
Grading Products Application Note	110
Grade and show product weight (磅):	110
Grade and show grade number (磅):	110
Replacement Part List.....	112
Scale Option List	116

Introduction

Introducing the Doran Scales Excel Series, Model 7400, 4300, 7000XL, 8000XL Digital Scale Indicator. This scale uses state of the art technology to provide you with a low cost solution to the most demanding weighing applications. With ease of use and setup in mind, the scale is simple to set up and ready to use. The Model 7400, 4300, 7000XL, 8000XL offers many features. A few of these features are listed below:

- NTEP certification for Class III installations to 10,000d (CoC 99-129A2 & 97-038A1).
- Display Resolution from 250 to 50,000 divisions.
- A six digit, 0.56" red LED display for easy reading.
- lb, kg, oz, g, lb-oz display units supported.
- Fully configurable duplex printer port with RS232 support.
- EEPROM nonvolatile data storage of all calibration and setup information.
- Microprocessor monitoring system to prevent scale failure under severe fault conditions.
- Support for up to four 350 ohm load cells.
- 115/230 VAC 50/60 Hz (jumper selectable) operation.
- Field selectable digital filtering.
- Software configurable remote push-button support (Optional).
- Non NTEP parameters are user configurable.
- Password protected, Front Panel Calibration Access Feature (Optional on 7400).
- 60 hour of battery operation, with built in charger (8000XL or Optional on other models).
- Six digit, 0.56" red LED remote display (Optional).
- 4-20mA analog output (Optional).
- Wired Ethernet Communication port (Optional).
- Wireless Ethernet Communication port (Optional).
- RS485 Communication port (Optional)
- USB Communication port (Optional)
- Four Internal Mechanical or Solid State Relay outputs for non-battery models (Optional)
- Eight External Relay outputs for non-battery models (Optional)
- Fiber Optic Communication (Optional)
- Multi-tone Audible Alarm (Optional)
- Peak and Hold, Product Grading software

Please be sure to read the entire manual to ensure obtaining all the benefits that the Excel Series can provide. If any questions arise, please feel free to contact the Doran Scales Technical Support Department at 1-800-262-6844.

Unpacking Your Scale

Before unpacking your Doran scale, please read the instructions in this section. Your new scale is a durable industrial product, but it is also a sensitive weighing instrument. Normal care should be taken when handling and using this product. Improper handling or abuse can damage the scale and result in costly repairs that will not be covered by the warranty. If you notice any shipping damage, notify the shipper immediately. Please observe the following precautions to insure years of trouble free service from your new scale.

- DO NOT drop the scale.
- DO NOT immerse the scale.
- DO NOT drop objects on the platform.
- DO NOT pick up the scale by the "spider."
- Carefully remove the scale from the shipping carton.

Scale Operation

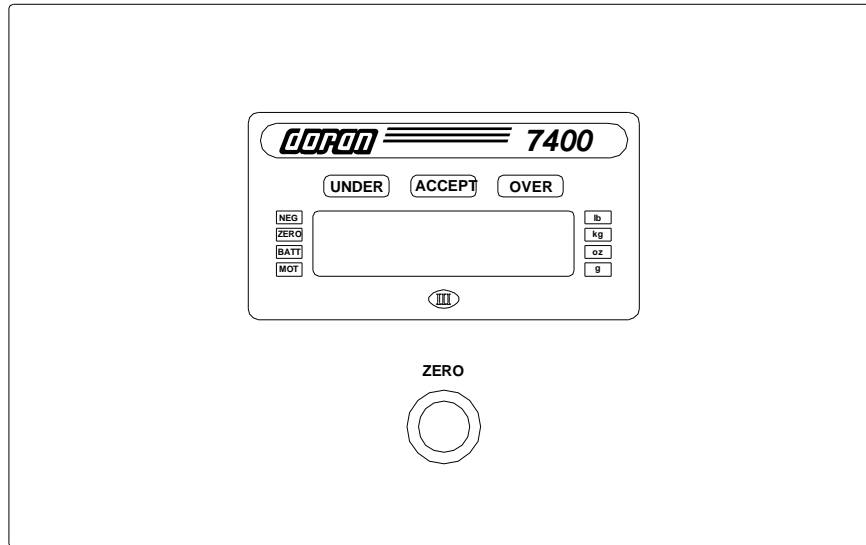

Fig. 1: Model 7400 Front Panel Layout

Model 7400:

The Model 7400 (Fig. 1) controls consist of the **ZERO** and optional **UNITS** buttons located under the main display. A six-digit LED display is used to provide weight indications, negative polarity (except lb/oz) and operator messages describing scale operation. Scale status such as motion (MOT), polarity (NEG) and center of zero (ZERO) is displayed on annunciators located to the left of the display area. Scale units are displayed on four annunciators located to the right of the main display. The Model 7400 has OVER, ACCEPT, UNDER indicators located above main display to indicate checkweight information.

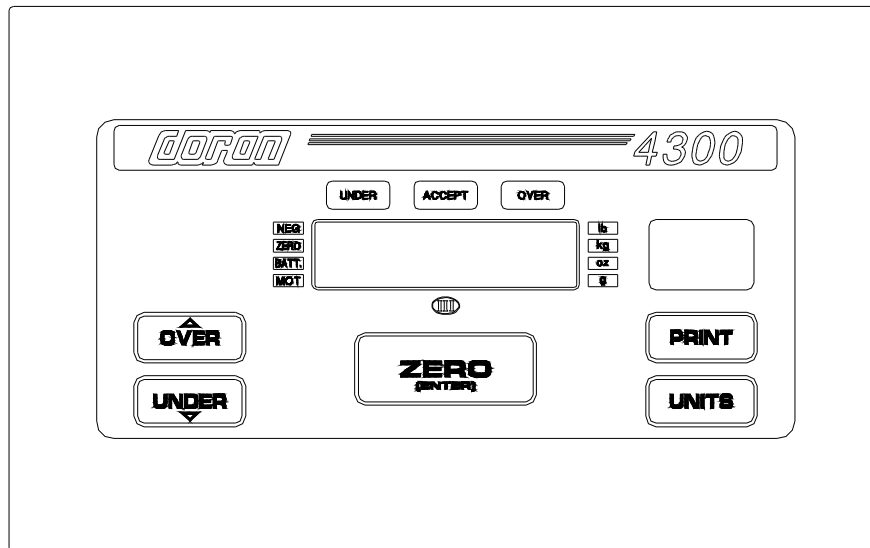

Fig. 3: Model 4300 Front Panel Layout

Model 4300:

The operational controls for the Model 4300 (Fig. 3) consist of the **ZERO**, **PRINT**, **UNITS**, **OVER**, and **UNDER** buttons. A six digit LED display is used to provide weight indications and operator messages describing scale operation. Scale status such as motion (MOT), polarity (NEG) and center of zero (ZERO) is displayed on annunciators located to the left of the display area. Scale units are displayed on four annunciators located to the right of the main display. The OVER, ACCEPT, UNDER indicators above main display are use to indicate checkweight information.

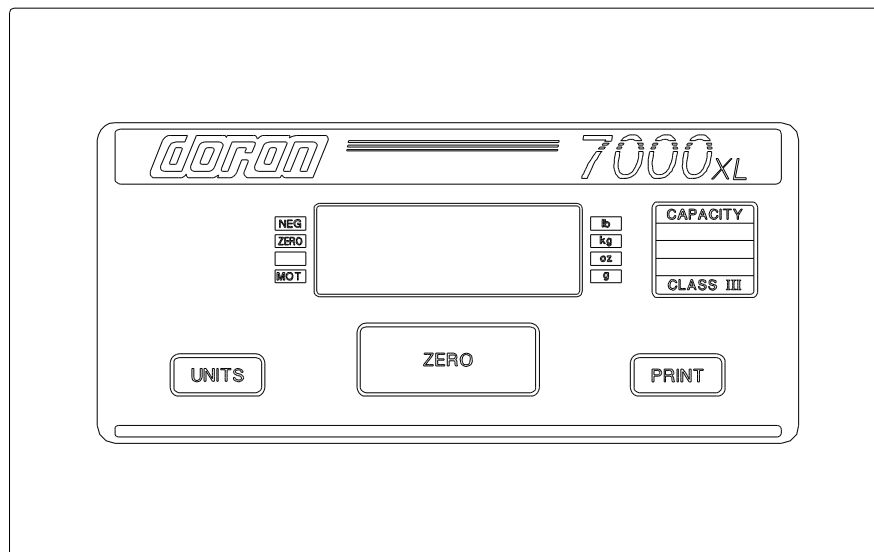

Fig. 4: Model 7000XL Front Panel Layout

Model 7000XL:

The operational controls for the Model 7000XL (Fig. 4) consist of the **ZERO**, **PRINT** and **UNITS** buttons. A six digit LED display is used to provide weight indications and operator messages describing scale operation. Scale status such as motion (MOT), polarity (NEG) and center of zero (ZERO) is displayed on annunciators located to the left of the display area. Scale units are displayed on four annunciators located to the right of the main display.

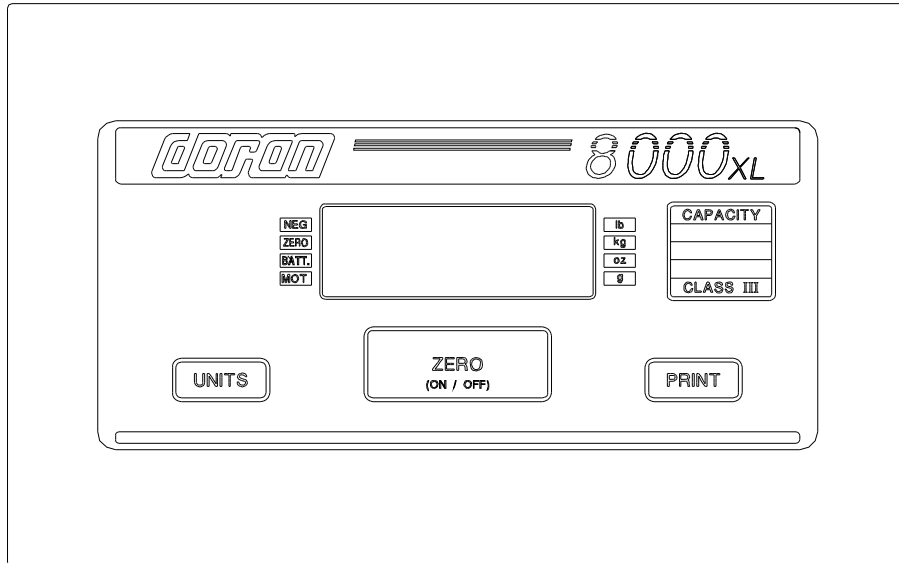

Fig. 5: Model 8000XL Front Panel Layout

Model 8000XL:

The operational controls for the Model 8000XL (Fig. 5) consist of the **ZERO (on/off)**, **PRINT** and **UNITS** buttons. A six digit LED display is used to provide weight indications and operator messages describing scale operation. Scale status such as motion (MOT), polarity (NEG), center of zero (ZERO), and low battery (BATT) are displayed on annunciators located to the left of the display area. Scale units are displayed on four annunciators located to the right of the main display.

Electrical Connections:

Prior to connecting your scale to power, check the serial number tag on the back of scale for the correct operating voltage. Verify that the power matches the rated voltage.

Be sure the AC power is not excessively noisy - this can occur if large inductive loads, such as solenoids or motors, are on the same power line. The scale has a filtered power supply to reduce the effects of normal line noise, but they cannot limit severe fluctuations. If problems occur, noise producing devices may have to be suppressed to minimize their effect.

Power Up:

Connect the Model 7400, 4300, 7000XL to a compatible power source. With the 8000XL or scale models with battery option, press and release ZERO button to turn on scale.

Basic Weighing Operation:

- 1) Remove all items from the scale platter.
- 2) Press the ZERO button to zero the scale. The weight display should now read zero.
- 3) Place an item on scale platter and wait for the motion (MOT) annunciator to go out, indicating a stable weight.
- 4) Read the weight on the scale display.

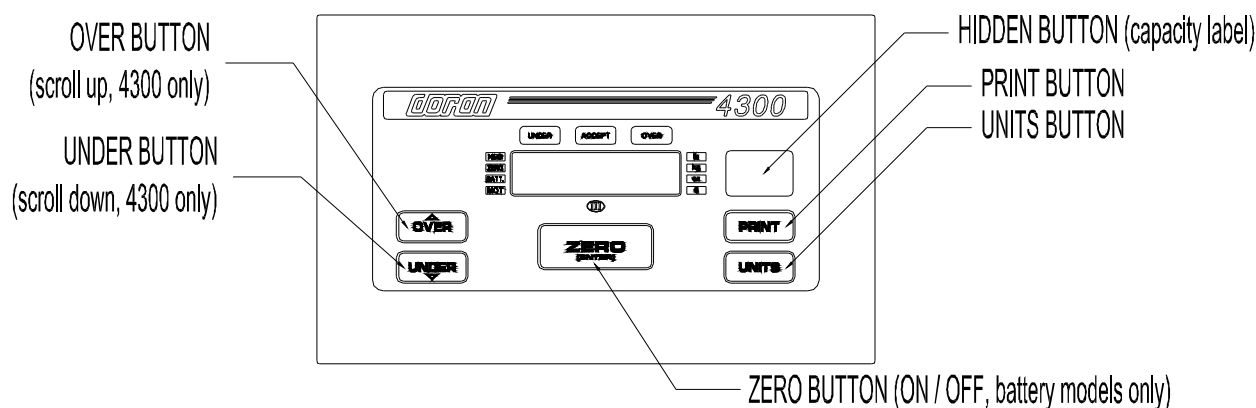

ZERO button:

The ZERO push button is also used to zero the scale prior to making a reading. The ZERO button functions over the full range of the scale in standard operation mode. In Legal For Trade mode, it will be limited to a zero band equal to $\pm 1.9\%$ of scale capacity. When the indicated weight is within the center of zero band (gross zero ± 0.25 divisions) the zero annunciator will light. To zero the scale, wait until the scale is stable and press the ZERO button. The scale will not zero if the scale is in motion. Motion is indicated when the MOT annunciator is lit. The scale is equipped with an optional "Zero on Demand" feature which zeros the scale upon the next stable reading. This option may be activated during the scale setup procedure.

UNITS button:(7400 optional)

The UNITS button permits the operator to select from six displayed weight units. Simply press the UNITS button and the units annunciator will indicate the correct weight in the current weight units "lb", "kg", "oz", "g", "lb-oz". The UNITS button can be configured to allow the selection of any combination of units listed above, preventing accidental selection of undesired units. See the Units Conversion Setup Parameter for details.

The UNITS button has a parameter located in the Push Button Function Setup, which can disable the UNITS button, and control the startup units selection every time the scale is turned on.

PRINT button:(7400 optional)

The PRINT button permits the operator to send data to a printer or other external devices. The user must wait for motion to stop before pressing the PRINT button. Motion is indicated when the MOT annunciator is lit. The current weight will then be transmitted to the printer. When the data is transmitted, the left most display digit will momentarily display a "r" to confirm data transmission. The 4300, 7000XL, 8000XL, and 7400(optional) has a "Print on Demand" feature which stores a PRINT request until the scale is stable. Once stable, the scale transmits the current weight. These models also have several automatic print options, which may be used to simplify printer operation. See the Data Communication Section for details on Further configuration. The PRINT button is active with RS-232, RS-485, Ethernet and wireless communication protocols.

4300 OVER / UNDER buttons:

The OVER and UNDER buttons are used to enter the weight values needed for checkweighing applications. In the simplest configuration (3 band), these buttons will enter the "check" weight by pressing either the OVER or UNDER button. When in this mode, the current weight is entered as the checkweighing limits. The default entry mode uses the OVER and UNDER buttons to take the current weight and scroll it up or down (arrows on the button indicate the scroll direction) until the desired "check" weight is reached. Once the desired value is reached, pressing ZERO (ENTER) will enter the desired value in the scale. The 4300 also offers five band check weighing.

Accumulator and Counter (Hidden button)

Press the Capacity Label to enter the accumulator / count recall mode. The display will show "ȡȡȡȡȡȡ" followed by the accumulated weight, then "ȡȡȡȡȡȡ" follow by the counter value. The display will continue to repeat this message until a key is pressed. The accumulator / counter recall mode will display the accumulator value in the units currently selected in the weigh mode. **Note:** Changing the current display units will clear both the accumulator and counter values.

Press UNITS button to exit the accumulator / counter recall mode without changing their values.

Press ZERO button, while in the accumulator / counter recall mode to clear the accumulator and counter values. The display will show "ȡȡȡȡȡȡ" and exit from the recall mode.

Press PRINT button, while in accumulator recall mode, to transmit the accumulator and counter values. Label buffer 4 contains the print string formatting for the accumulated weight and counter value. See Output Formats in the Parameter section and Label Buffer default settings for more details.

The accumulator and counter is incremented once every time a manual or automatic accumulation occurs. When the weight has been added to the accumulator and the counter has been incremented, the left most display digit will momentarily display a "a" to confirm operation. The maximum value that can be shown for the accumulator and

counter is 6 digits or 999999. When the maximum value is reached, the accumulator or counter will rollover. Note: The accumulator and counter feature can only be used in a non Legal For Trade application.

Battery Operation

The 8000XL and other models with battery option are equipped with a self-contained Rechargeable Sealed Lead-Acid battery and charging circuit, both internal. The scale is designed to run continuously for 60 hours (with one 350 ohm loadcell) on a fully charged battery. To significantly extend this battery life, enable the Unit On Timer which will power down the scale automatically after a period of non-use. Multiple load cells, Fiber Optic, Ethernet, 4-20mA, Wireless Communication(12 hours), Remote Display or Relay options will reduce battery life. For multiple load cell applications, battery life is significantly reduced. For example, with a four, 350 Ω load cell configuration, the low battery indication will begin at about 39 hours of continuous use. Load cells with higher input impedance values such as 1000 Ω will add up to 8 hours of additional battery life.

The charging circuit will fully charge the battery in approximately four to eight hours whether the scale is on or off. To charge the battery, simply plug the line cord into a standard 115V (230V optional) wall outlet. The scale can be used while recharging the battery, in fact, the scale can be used with the AC charger cord plugged in on a continuous basis. **Note:** 8000XL installed with multiple load cells, Fiber Optic, Ethernet, 4-20mA, Wireless Communication, Remote Display or Relay options will increase charge time.

If an AC power failure occurs with the charger plugged in, the scale's battery immediately takes over to provide uninterrupted scale operation.

The scale's charging circuit is a two-stage, current limited charger. The scale will sense the charge condition of the battery and charge at a high rate when the battery is depleted. When the battery comes up to a fully charged state, the charger will switch to a trickle mode which maintains the battery at a fully charged state without overcharging.

The "BATT" annunciator indicates that the battery is in need of recharging. The scale will continue to operate accurately for approximately one hour (with one 350 ohm loadcell) after the "BATT" annunciator is lit. When the battery is too low to run the scale, the scale simply turns off and will not operate again until the battery is recharged. At this point, when the ZERO (ON/OFF) is pressed, the "BATT" annunciator will be lit as the scale performs its display test and then the scale will shut down immediately.

The battery should be able to support at least 300 recharges before the end of the battery life is reached. This is an estimate as many factors can affect battery life like, severe temperature changes and charging before the scale's displays Low Battery.

Turn Off: (8000XL or Battery option)

- 1) To turn off manually, press and hold the ZERO push button until the display shows "rEL Pb." Then release, the ZERO button and, the scale will turn off.
- 2) The scale will turn off automatically at the end of the Unit On Timer setting when that mode is selected (see Unit On Timer parameter).

Low Battery Indication: (8000XL or Battery option)

The "BATT" annunciator indicates that the battery is in need of recharging. Once the "BATT" annunciator turns on, there will be approximately one more hour of battery life before the scale shuts down. When the battery is too low to run the scale, the scale simply turns off and will not operate again until the battery is recharged. The scale remains accurate and useable even with the "BATT" annunciator on.

Checkweigh Operation

7400 Zero Band Checkweighing Operation:

- 1) Remove all items from the scale platter. Place the target weight on the scale.
- 2) Press ZERO to zero the scale. The weight display should now be zero. Remove the target weight.
- 3) Place an item on scale platter and wait for the motion (MOT) annunciator to turn off, indicating a stable weight.
- 4) If the item is heavier than the over limit, the OVER indicator will light, If the item is lighter than the under limit, the UNDER indicator will light. If the weight is between the limits, the ACCEPT indicator will light.

NOTE: The over and under tolerances around zero can be configured with the "0.0." parameter. Zero Band checkweighing is the only checkweighing operation available for the model 7400.

4300 Over, Under and Accept Checkweighing Operation:

- 1) Remove all items from the scale platter.
- 2) Press ZERO to zero the scale. The weight indication should now be zero.
- 3) Place an item on scale platter and wait for the motion (MOT) to turn off, indicating a stable weight.
- 4) If the item is heavier than the over limit, the OVER indicator will light, If the item is lighter than the under limit, the UNDER indicator will light. If the weight is between the limits, the ACCEPT indicator will light.

4300 Digital Entry and Recall of Over and Under Limits:

- 1) Press and release the OVER button. The OVER and ACCEPT indicators will light followed by momentary "OVER" message.
- 2) Current weight value of saved limit will be displayed.
- 3) The scale is in the scroll mode. Press either the OVER or UNDER button to increase or decrease the limit value. Holding a button longer will cause the count to accelerate. Press the UNITS or PRINT button to cancel the check limit value entry. The display will read "LIMIT."
- 4) Once the desired limit is reached, press ZERO to save the limit. The display will read "LIMIT."
- 5) To enter the under limit, press and release the UNDER button. The UNDER and ACCEPT indicators will light followed by momentary "UNDER" message. Then repeat steps 2 to 4.

NOTE: The model 4300 is configured at the factory for the digital entry of over and under limits. Other entry configurations are available, see Checklimit Entry Mode Menu "L.L." for more details.

4300 Digital Entry of Over and Under Limits: (optional configuration)

- 1) Zero the scale.
- 2) If available, place an item with the desired weight on the scale.
- 3) Press and release the OVER button. The OVER and ACCEPT indicators will light followed by momentary "OVER" message.
- 4) The scale is in the scroll mode. Press either the OVER or UNDER button to increase or decrease the limit value. Holding a button longer will cause the count to accelerate. Press the UNITS or PRINT button to cancel the check limit value entry. The display will read "HOLD."
- 5) Once the desired limit is reached, press ZERO to save the limit. The display will read "SAVE."
- 6) To enter the under limit, press and release the UNDER button. The UNDER and ACCEPT indicators will light followed by momentary "UNDER" message. Then repeat steps 4 and 5.

NOTE: To digitally adjust platform weight for over and under limits, the Checklimit Entry Mode "L.E." menu is set to "555" option. See Checklimit Entry Mode "L.E." menus for more details.

4300 Push-button Entry of Over and Under Limits: (optional configuration)

- 1) Zero the scale.
- 2) Place an item with the desired over weight on the scale.
- 3) Press and release the OVER button. The OVER and ACCEPT indicators will light, followed by displaying "OVER", the current weight, then "SAVE" to indicate the limit has been saved.
- 4) Remove the over item and place an item with the desired under weight on the scale.
- 5) Press and release the UNDER button. The UNDER and ACCEPT indicators will light followed by displaying "UNDER", the current weight, then "SAVE", to indicate the limit has been saved.

NOTE: The Push-button entry of over and under limits ("Pb") is an optional configuration in the Checklimit Entry Mode Menu. See Checklimit Entry Mode parameter ("L.E.") for more details.

4300 Five Band Checkweighing Operation: (optional configuration)

- 1) Remove all items from the scale platter.
- 2) Press ZERO to zero the scale. The weight display should now be zero.
- 3) Place an item on scale platter and wait for the motion (MOT) annunciator to turn off, indicating a stable weight.
- 4) If the item is heavier than the high limit, the OVER indicator will flash. If the item is heavier than the "over" limit but lighter than the "high" limit, the OVER indicator will turn on. If the item is lighter than the low limit, the UNDER indicator will flash. If the item is heavier than the low limit but lighter than the under limit, the UNDER indicator will turn on. If the weight heavier than the under limit but lighter than the over limit, the ACCEPT indicator will light.

NOTE: The Five band checkweighing operating mode ("5bA", "5b5", "5bE", "5bb") is available in four different optional configurations in the Check Weighing Operation Mode Menu. See Check Weighing Operation parameter "L.O." for more details.

4300 Digital Entry and Recall of High and Low Limits:

- 1) Press and hold the OVER button until the display shows "H .9h" and the OVER and ACCEPT indicators flash.
- 2) Current weight value of saved limit will be displayed.
- 3) Press either the OVER or UNDER button to increase or decrease the limit value. Holding a button longer will cause the count to accelerate. Press UNITS or PRINT to cancel the check limit value entry. The display will read "HbOrE."
- 4) Once the desired limit is reached, press ZERO to save the limit. The display will read "dOnE."
- 5) To enter the UNDER limit, press and hold the UNDER button until the display shows "L.uuu" and the UNDER and ACCEPT indicators flash.
- 6) Then follow steps 2 to 4.

NOTE: To digitally enter in high and low limits, the following parameters must be configured. The Check Weighing Operation parameter "L.O." set to any of the menu options ("5bA", "5b5", "5bE", "5bb") that has the five band check weighing operating mode. The Checklimit Entry Mode "L.E." menu is set to "5Lr" option. See Check Weighing Operation "L.O." and Checklimit Entry Mode "L.E." menus for more details.

4300 Digital Entry of High and Low Limits: (optional configuration)

- 1) Zero the scale.
- 2) If available, place an item with the desired weight on the scale.
- 3) Press and hold the OVER button until the display shows "H .9h" and the OVER and ACCEPT indicators flash.
- 4) Press either the OVER or UNDER button to increase or decrease the limit value. Holding a button longer will cause the count to accelerate. Press UNITS or PRINT to cancel the check limit value entry. The display will read "HbOrE."
- 5) Once the desired limit is reached, press ZERO to save the limit. The display will read "dOnE."
- 6) To enter the UNDER limit, press and hold the UNDER button until the display shows "L.uuu" and the UNDER and ACCEPT indicators flash.
- 7) Then follow steps 4 and 5.

NOTE: To digitally enter in high and low limits, the following parameters must be configured. The Check Weighing Operation parameter "L.O." set to any of the menu options ("5bA", "5b5", "5bE", "5bb") that has the five band check weighing operating mode. The Checklimit Entry Mode "L.E." menu is set to "5L5" option. See Check Weighing Operation "L.O." and Checklimit Entry Mode "L.E." menus for more details.

4300 Push-button Entry of High and Low Limits: (optional configuration)

- 1) Zero the scale.
- 2) Place an item with the desired high weight on the scale.
- 3) Press and hold the OVER button until the scale displays "H 0.0", the current weight then "0.000". The limit has been saved.
- 4) Remove the high item and place an item with the desired low weight on the scale.
- 5) Press and hold the UNDER button until the scale displays "L 0.0", the current weight, then "0.000". The limit has been saved.

NOTE: The Push-button Entry of high and low limits is available when the following parameters are configured. The Check Weighing Operation parameter "C.O." set to any of the menu options ("5bA", "5bS", "5bt", "5bb") that has the five band check weighing operating mode. The Checklimit Entry Mode "C.E." menu is set to "Pb" option. See Check Weighing Operation "C.O." and Checklimit Entry Mode "C.E." menus for more details.

Serial Entry and Recall of Limits:

All limits (setpoint values) can be entered or recalled by way of serial port using the ESx and RSx commands. Where x would be the setpoint number 1 - 8. See Data Communication Section for further information.

Setpoint Operation

All scale models can be configured to Setpoint Operation. The Setpoint Operation is available when the following parameters are configured. The Check Weighing Operation parameter "C.O." set to any of the menu options "SER" or "SES". The eight available outputs on the optional Digital Output Board are nominally configured to each of the Setpoint limits.

There are two different methods of Setpoint entry of limits. The first method is available on all models and the second method is only available on the model 4300.

Digital Entry and Recall of Setpoint Limits:

- 1) The entry and recall of Setpoint limits is performed by entering the Calibration mode. Press and release UNITS button until the display shows "C.E. n0" for Setpoint Entry menu prompt.
- 2) Press ZERO button to select yes option "C.E. YES" and then UNITS button to enter the Setpoint Entry menu. The display will show the "SP 1 ADJ" message for Setpoint 1 Adjustment option.
- 3) Press and release the ZERO button to recall saved Setpoint 1 limit value.
- 4) With the limit value showing, the scale is now in the scroll mode.
- 5) Press either the OVER or UNDER button to increase or decrease the limit value. Holding a button longer will cause the count to accelerate. Press UNITS or PRINT to cancel the check limit value entry. The display will read "Roll over."
- 6) Once the desired limit is reached, press ZERO to save the limit. The display will return back to showing the current Setpoint Adjustment message "SP 1 ADJ".
- 7) To enter in the next Setpoint limit, press and release the UNDER button. The display will show "SP2 ADJ" message for Setpoint 2 Adjustment option. Then repeat steps 3 to 5.

NOTE: To select a different Setpoint limit number. Use the UNITS button to scroll through the 8 available Setpoint Adjustment numbers to enter or recall their limit value.

4300 Digital Entry and Recall of Setpoint Limits:

- 1) Press and release the UNDER button, the display will show "SP1 !" message.
- 2) Press and release the ZERO button to recall saved Setpoint 1 limit value.
- 3) With the limit value showing, the scale is now in the scroll mode. Press either the OVER or UNDER buttons to increase or decrease the limit value. Holding a button longer will cause the count to accelerate. Press the UNITS button to cancel the Setpoint limit value entry. Press the UNITS or PRINT button to cancel the Setpoint limit value entry. The display will read "Roll over."
- 4) Once the desired limit is reached, press ZERO to save the limit. The display will read "done."
- 5) To enter in the next Setpoint limit, press and release the UNDER button and then the OVER button to select Setpoint 2 limit. The display will show "SP1 2" message. Then repeat steps 2 to 4.

NOTE: To select a different Setpoint limit number. Use the UNITS or UNDER buttons to scroll through the eight available Setpoint Adjustment numbers to enter or recall their limit value.

NOTE: To digitally enter in Setpoint limits, the following parameters must be configured. The Checklimit Entry Mode "L.L." menu is set to "555" option. See Checklimit Entry Mode "L.L." menus for more details.

Installation Guide

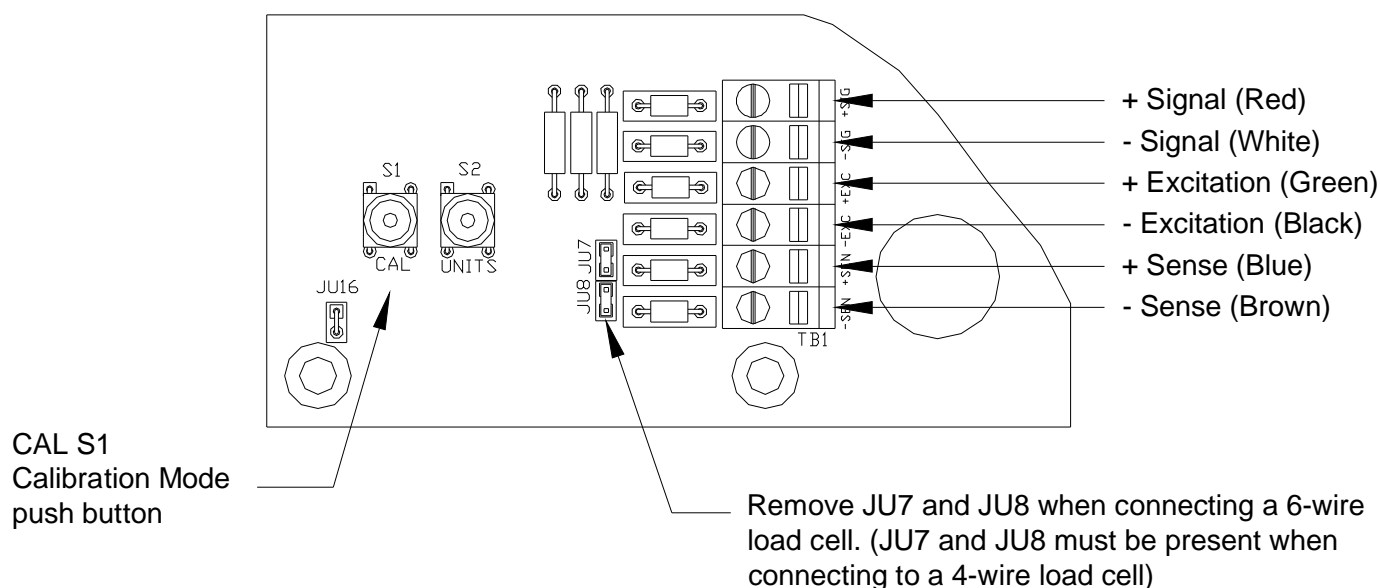

Fig. 6: Load Cell connections

Connecting a load cell or configuring jumpers requires the removal of the rear panel.

Removing the Rear Panel

Before you remove the rear panel, remove the AC or battery power supply from the scale. Removing the rear panel requires a 5/16" nut driver. Remove all four screws and set aside. Do not loosen any watertights on the back panel that do not require modification.

Replacing the Rear Panel

Secure any connections that have been modified. When replacing the rear panel it is necessary to mount the gasket, all four screws and gasket washers. Tighten all four screws to 20 ft-lb to achieve proper sealing. It is normal for the rear panel to dimple slightly when the screws are tightened to 20 ft-lb. Tighten any modified watertight until the cable exiting the watertight can no longer slide through the watertight – this is usually finger tight. With an open-end wrench, apply a quarter turn to the watertight for a tight seal.

Load Cell and Power Connections:

Load cell connections are made through a terminal block "TB1" located at the bottom center of the main board (see Fig. 6). The power cord connects to a connector "J1" adjacent to the transformer (see Fig. 7). These connections are accessible by removing the rear cover screws and laying the rear panel and front of scale on the work surface.

To install a single load cell, remove the rear panel and check the JU7 and JU8 jumper configuration. Remove JU7 and JU8 for a six-wire load cell. Inversely, JU7 and JU8 must be in place for a four-wire load cell. Locate the ferrite core kit and read "load cell cable grounding and ferrite assembly" instruction sheet. Thread the load cell wires through the ferrite core as shown in Fig. 11. Connect the load cell wires by inserting the tip of a screw driver into the round hole located on the top of the terminal block TB1. Use the screw drive blade to open the adjacent slot, insert a striped end of a single loadcell wire into slot. Once wire end has been inserted, remove screw driver, wire should now be capture in terminal slot. Repeat for all remaining loadcell wires.

RS232 and Remote Switch Connections:

The Remote Switch and Serial Communications terminal is found on the top of the main board next to the transformer. These option connections are accessed by removing the rear cover. Connections are made by inserting each lead of the option cable into P2 terminal block (see Fig. 7). Like the load cell cable and power cord, the option cables are passed through watertight fittings mounted on the back of the indicator.

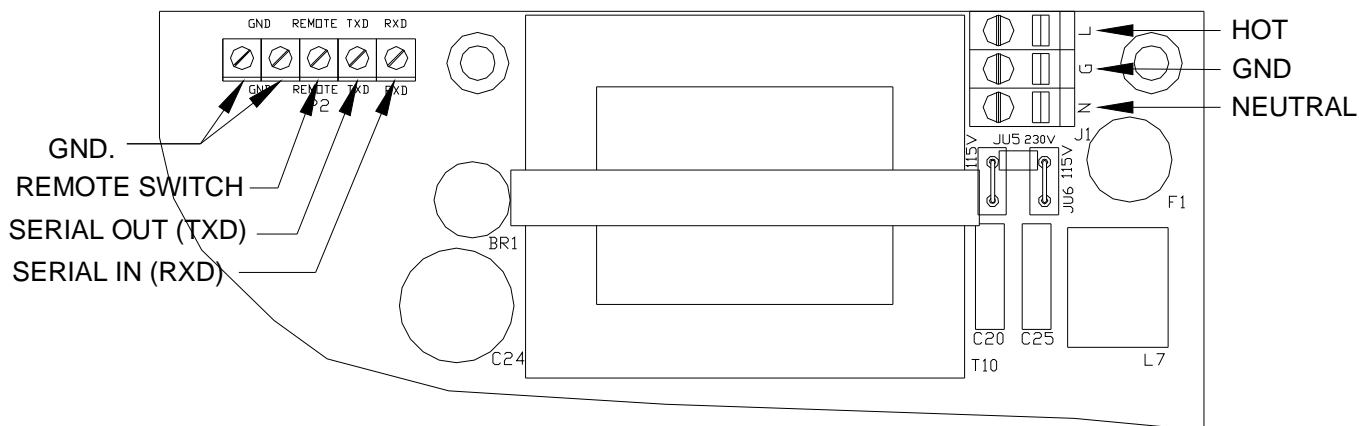

Fig. 7: Serial, Remote SWITCH and power Connections

Calibration Guide

Entering Calibration and Parameter Setup Mode:

The Calibration and Parameter Setup Mode can be entered by three different ways.

- 1) The **Front Panel CAL Access Feature on power-up** (Available only on the 4300, 7000XL, 8000XL models or on models that have an optional UNITS push button installed.) To enter the calibration mode, power up the scale while pressing the ZERO and the UNITS button at the same time. When the "r EL P b" is shown, release both buttons. The display will momentarily show "E n t C d" then go blank. Press the ZERO button five times, the display will indicate the number of times the button has been pressed. When " 5 " is displayed then press and release the UNITS button and wait a few seconds. **Note:** If the code is not entered before the timer is finished, the scale will bypass code entry and enter the normal run mode. See Parameter Setup section for more information.
- 2) The **Front Panel CAL Access Feature after power-up** (Available only on the 4300, 7000XL, 8000XL models.) To enter the calibration mode, first press and hold the UNITS and then the ZERO button until the Audit counters and Parameter review starts. After the Audit counters are displayed, and during the parameter review, press and release the Hidden (Capacity Label) button. The display will momentarily show "E n t C d" then go blank. Press the ZERO button five times, the display will indicate the number of times the button has been pressed. When " 5 " is displayed then press and release the units button and wait a few seconds. **Note:** If the code is not entered before the timer is finished, the scale will bypass code entry and enter the normal run mode. See Parameter Setup section for more information.
- 3) The **CAL switch S1** is a momentary push button located in the lower left corner of main PC. Board (see Fig. 6). To access the calibration switch remove the meter's back cover.

Capacity:

The Capacity selection is performed by entering the Calibration mode. Press and release UNITS button until the display toggles between "CAP AU" and the current capacity "XXXXXX" (where "XXXXXX" can be any valid capacity in lb or kg. The units annunciator to the right of the weight display will indicate either lb or kg. The Calibration and capacity setup unit is defined by the startup units "S.U." parameter setting.)

Once the current capacity appears, press and release ZERO button to begin capacity adjustment. The first display digit located all the way to the right, will begin to flash. Press ZERO to increment value of digit. Press UNITS to select the next digit (shift left), or PRINT to select the previous digit (shift right). The digit that has been selected will starting flashing. To enter a decimal point for the selected digit,. Press and hold the UNITS button, then press ZERO to toggle the decimal point on or off. Once the desired capacity is displayed, press UNITS until "E n t b y" parameter is displayed. When finished, return to the run mode by pressing the CAL switch or scroll through the menu with the UNITS button to "donE n". Select "donE y" by pressing the ZERO button, and then press the UNITS button to exit to the run mode.

Once the desired capacity has been selected, place the correct capacity label on the front panel, to the right of the display.

NOTE: On scales with factory installed platforms, the capacity is set at the factory. It will not be necessary to set the scale capacity.

Resolution:

After Capacity has been entered, the scale's Resolution (Count-By) will automatically be set for a nominal 5000 division level. To enter in a different Count-by setting, the scale must be in the Calibration mode. Press and release the UNITS button until the display momentarily shows "Cnt bY" and then starts flashing the current Resolution level "XXXXXX" (where "XXXXXX" can be any valid count-by value between 100 and 45,000 divisions of capacity. The units annunciator to the right of the weight display will indicate either lb or kg.

Once the current Count_By level appears, press and release ZERO button to increment value through the available range. Once maximum level has been reached, the level will roll-over to the minimum value. When finished, return to the run mode by pressing the CAL switch or scroll through the menu with the UNITS button to "done n". Select "done Y" by pressing the ZERO button, and then press the UNITS button to exit to the run mode.

Calibration:

1. Enter Calibration mode, then press and release the UNITS until "CAL 0" appears on the display.
2. Remove all weight from the scale platter and wait for about 10 seconds. Press ZERO and wait for the display to count down to 0. If the calibration zero was in range, the display will return with "CAL F5". If the display returns with a "CAL 0", repeat the process.

NOTE: If "r9 Err" appears on the display, the calibration zero is out of range. Press ZERO to clear error. Refer to the A/D Ranging section for additional information.

The scale can be calibrated using (a) full capacity weight, (b) half capacity, (c) quarter capacity, (d) one tenth capacity, or (e) any capacity weight between 2% and 100% of full scale (Not available on the 7400).

To select the weight to calibrate the scale, press the UNITS button and select one of the four following capacities.

- CAL F5: Full load calibration.
- CAL .50: Half load calibration. (50% of full load)
- CAL .25: Quarter load calibration. (25% of full load)
- CAL .10: 1/10th load calibration. (10% of full load)

If you want to select a weight between 2% and 100% of capacity, select the capacity range above closest to the desired weight. Then scroll to the exact weight by pressing CAPACITY to go increase the weight or PRINT to reduce the weight. This is not available on the Model 7400.

3. To complete the calibration process, place the correct weight on the platter and press ZERO and wait for the display to count down to 0. If the span calibration was in range, the display will return with "done". If the display returns with a "CAL 0", repeat steps 2 and 3.

NOTE: If "Error" appears on the display, the calibration span is in a negative range. Check polarity of load cell connection (see Fig. 6) and repeat Calibration.

NOTE: If "Span E" appears on the display, the calibration span is out of range. Press ZERO to clear this error. Refer to the A/D Ranging section for additional information.

NOTE: Calibration at 2% of capacity has been provided as a convenience to customers with high capacity scales in remote or inaccessible locations. Scales calibrated at 2% of capacity are more likely to have significant errors at full capacity than are scales calibrated at 25% or 50%. Doran Scales recommends that all scales be calibrated at full capacity whenever possible. 2% calibration should not be used when calibrating scales for legal for trade applications. It is the responsibility of the installer/user to ensure that NTEP accuracy is achieved after any calibration.

A/D Ranging:

(Refer to this section only if you encounter a calibration problem)

NOTE: On scales with factory installed platforms, the zero and span will lie within permissible limits. Load cell signal input range 0.283 mV/V to 5 mV/V.

- 1) Enter Calibration mode by using Front Panel CAL Access feature or by pressing the CAL switch (S1).
- 2) Press and release UNITS or PRINT until in the raw counts mode.
- 3) Return the scale platform to "No Load" by removing all items from the platform.
- 4) Record the "No Load" counts. The "No Load" or dead load raw counts must be between 130,000 and 393,000 counts. If the readings are outside of the limits specified, change dead load until you meet these requirements.
- 5) Place "Full Load" on the platform and record the "Full Load" counts. Subtract the "No Load" counts from the "Full Load" counts to calculate the "span". Refer to Table 1 and verify that the span falls within the limits specified range. The "Full Load" raw counts (span + dead load) should not exceed 900,000 counts.
- 6) When using 50%, 25% or 10% of full load to calibrate, refer to Table 1 for Full, 50%, 25%, 10% span ranges.

Calibration requirements in raw counts		
Platform load	Minimum span	Maximum span
Full	30,000	500,000
50%	15,000	250,000
25%	7,500	125,000
10%	3,000	50,000

Table 1: Calibration requirements in raw counts

Parameter Setup

The Excel Series has 54 calibration and parameters setup menu items, which can be accessed three different methods, CAL switch and the Front Panel CAL Access Feature on both power-up or after power-up. The Front Panel CAL Access Feature allows the user to change the scale's calibration and parameter settings by way of entering in a password code. This Feature is only available when scale is not configured for legal for trade Switch mode (see Operating mode Setup Menu).

Entering and Exiting the Calibration and Parameter Setup Mode:

The Calibration and Parameter Setup Mode can be entered by three different methods.

1) Front Panel CAL Access Feature during power-up

The Front Panel CAL Access Feature during power-up is only available when the scale is in an Audit Trail mode ("0P" = "5LD", "44", "PH", "PH5", "PHL", "P5L", "95L", "9nL"). This feature is not available on 7400 without the units push button option. To enter the calibration mode, power up scale while pressing the ZERO and the UNITS button at the same time. When the "rEL P6" is shown, release both buttons. The display will momentary show "EL Ld" then go blank. Press the ZERO button five times, the display will indicate the number of times the button has been pressed. When "5" is displayed then press and release the UNITS button and wait a few seconds. **Note:** If the code is not entered before the timer is finished, the scale will bypass code entry and enter the normal run mode.

2) Front Panel CAL Access Feature after power-up

The Front Panel CAL Access Feature after power-up is only available when the scale is in an Audit Trail mode ("0P" = "5LD", "44", "PH", "PH5", "PHL", "P5L", "95L"). This feature is not available on the 7400 model. To enter the calibration mode, first press the UNITS and then ZERO buttons and hold them until the parameter review starts. After the Audit counters are displayed, press and release the Hidden (Capacity Label) button. The display will momentary show "EL Ld" then go blank. Press the ZERO button five times, the display will indicate the number of times the button has been pressed. When "5" is displayed then press and release the UNITS button and wait a few seconds. **Note:** If the code is not entered before the timer is finished, the scale will bypass code entry and enter the normal run mode.

3) Switch Access Mode

Scale must be in Legal for Trade Switch mode ("0P" = "445"). Apply power to the Scale. Then momentarily press the **CAL switch** S1 located in the lower left corner of main PC. Board (see Fig. 6). The calibration switch can be accessed by removing the meter's back cover. **Note:** Parameter and Calibration audit counters will be hidden when set in this mode. **Warning:** do not press CAL switch while powering up scale, this will cause the scale to reset all parameter settings.

The scale will Momentarily display Parameter and Calibration audit counters (Audit Trail mode only). The indicator will then display the first menu item, "CAL RD" and "25"

(Where 25 can be any valid capacity in lb or kg). Press the UNITS button to access the next menu item.

To exit the Calibration and Parameter Setup Menu, momentarily press the CAL switch or scroll through the menu options, by pressing the UNITS button, until "done n" appears. Press ZERO button until "done 3" appears and then press the UNITS button. The indicator will return to the normal weighing mode. If any menu selections were changed, The new values will be saved

Note: No new setup information is saved until the scale displays "SAVED" and returns to the RUN mode. In the event of a power failure while in the Calibration and Parameter Mode, any changes that have been made will be lost.

Stepping through the menu parameters:

Once the Calibration and Parameter Setup Mode has been entered, you may step through the menu by pressing and releasing UNITS. Some items in the menu contain sub menus (see below) which can be enter by selecting "YES" and pressing UNITS. A different display prompt will appear for each parameter in the menu.

The Setup Parameters Explained on the following pages corresponds to the parameters available in the Calibration Setup Menu.

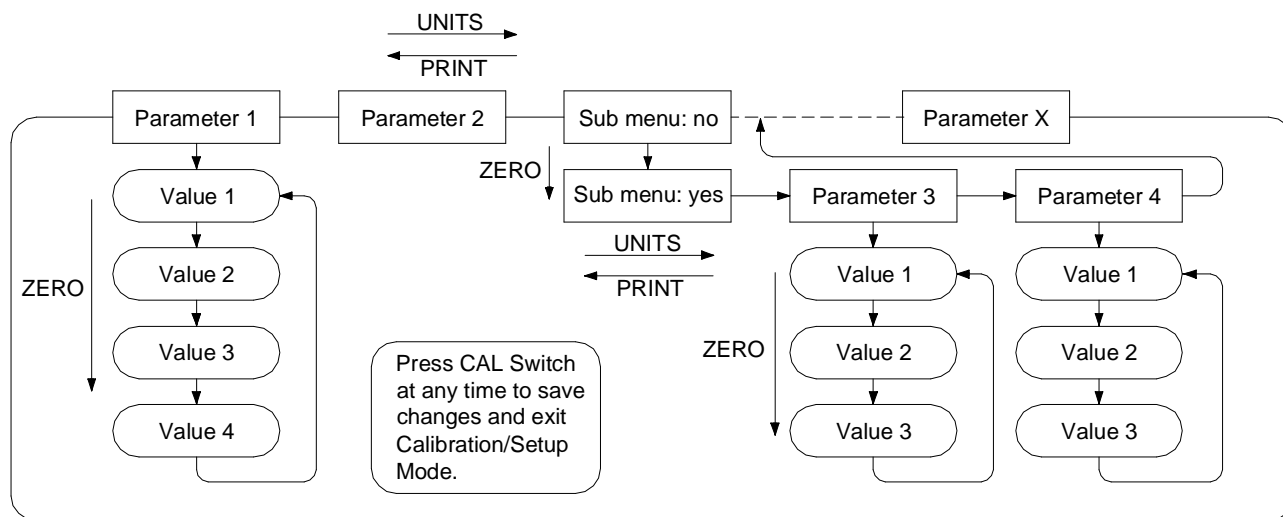

Changing a Parameter settings:

After finding the desired menu item (parameter), the settings for that parameter may be changed. Press and release ZERO to scroll through the list of settings for that item. The list of choices will repeat if you keep pressing and releasing ZERO. When you have found the desired setting, press UNITS to go to the next menu item.

Parameter Review of Calibration and Setup Values:

The Parameters values for the indicator may be quickly reviewed without entering in the Calibration and Parameter Setup Mode. Remove power and press and hold the **ZERO** button while you apply power. Hold the button until the scale begins to scroll through each of the parameters. The button may be released anytime after the review has begun. After parameters are displayed, scale will then go to the normal weighing mode automatically. Note: The Parameter and Calibration audit counters are the first item to be displayed when the scale is in Legal for Trade / Audit Trail mode ("00" = "44").

Legal for Trade Restrictions:

When the Legal for Trade mode is enabled, it automatically disables some menus and parameter options. This is done to comply with NTEP requirements. The menus and parameter sections are shown on the following pages. Those menus and/or parameters not available when in the Legal for Trade mode are marked by an asterisk.

Audit Counters:

When entering calibration mode, the Parameter audit counter and the Calibration audit counter will momentarily be displayed. The Parameter audit counter only increments when [R], [t], [4], [2], [n.n.], [5], [0], [0] values are changed (ZERO pb is pressed). The Calibration audit counter only increments when Calibration Zero [R] 0, and Span [R] XX are performed. **Note:** when scale is in Legal For Trade Switch mode ("00" = "44"), the Audit counters will not be displayed.

Software part number and revision level:

During power up, the scale will display several messages. The first message is a display test with all the LED segments on, "000000". Next, the scale will show the software part number "5 102" followed by the software revision level "r 3.0" or higher. Please have ready the software part "102" and the revision level, when contacting our service department.

Setup Parameters Explained

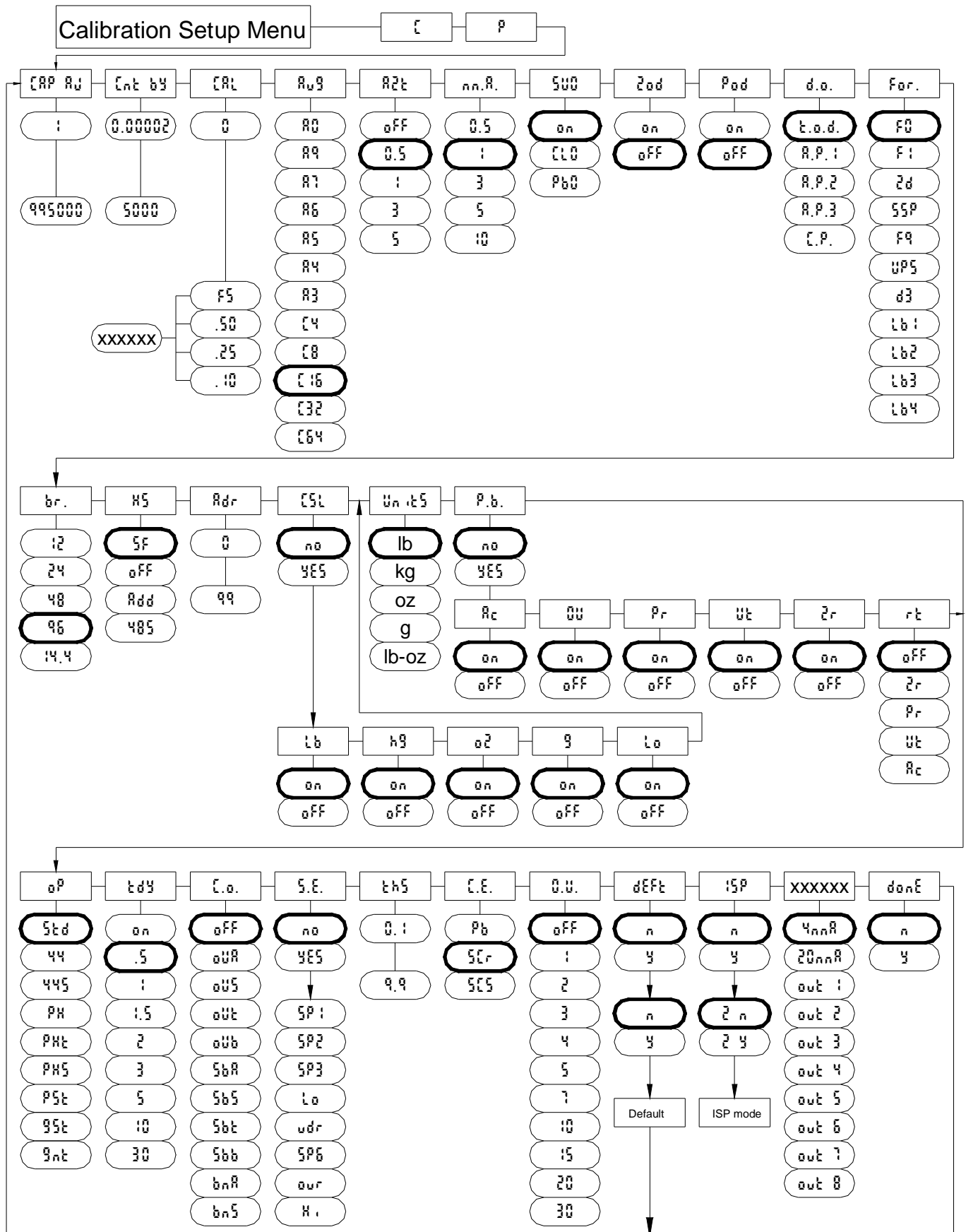

Capacity Setup Menu

[CAP AD]	Capacity Adjustment Menu Allows the selection of scale capacity.
1 - 999000	1 lb / kg to 999,000 lb / kg Press ZERO in increase column value, UNITS to select next column, PRINT to select previous column, UNITS & ZERO to toggle decimal point.

NOTE: Capacities \geq 60,000 lb, oz units are disabled.
 Capacities \geq 2000 lb, grams units are disabled
 Capacities \geq 1000 lb, lb-oz units are disabled

Count By Setup Menu

[Cnt by]	Count By Setup Menu (Resolution) Allows the selection of scale division size.
0.00002 5000	0.00002 lb / kg to 5000 lb / kg Selection with be limited by capacity.

Calibration Menu

[CAL]	Zero Calibration Mode.
0	Calibration Zero Press ZERO to perform calibration of the scale zero. Successful calibration is indicated by "[CAL F5]"

NOTE: The scale will automatically adjust the offset and gain to compensate for dead load and span. When making these adjustments, the scale may ask you to repeat zero calibration immediately after performing a zero calibration or after a span calibration. Successful calibration is indicated by "[CAL F5]"

[CAL]	Span Calibration Mode. (Does not appear if CAL 0 is not activated.)
F5	Full load calibration.
.50	Half capacity calibration.
.25	Quarter capacity calibration.
.10	1/10th of capacity calibration.
XXXXXX	By pressing the hidden or print push button weight value can be entered in. (note: XXXXXX will be the dialed in weight value. This feature is not available on 7400.)

NOTE: For maximum accuracy, Doran Scales recommends that all scales be calibrated at full capacity. When location or installation make it difficult to bring full capacity weights to the scale, calibration with as little 10% of capacity is possible.

Digital Filter Setup Menu

Avg	Averaging mode Determines the number of samples to average
A0	Stabil-izer [®] auto averaging. All readings are averaged. Display updates 10 times a second.
A9	Stabil-izer [®] auto averaging. All readings are averaged. Display updates 9 times a second.
A7	Stabil-izer [®] auto averaging. All readings are averaged. Display updates 7 times a second.
A6	Stabil-izer [®] auto averaging. All readings are averaged. Display updates 6 times a second.
A5	Stabil-izer [®] auto averaging. All readings are averaged. Display updates 5 times a second.
A4	Stabil-izer [®] auto averaging. All readings are averaged. Display updates 4 times a second.
A3	Stabil-izer [®] auto averaging. All readings are averaged. Display updates 3 times a second.
C2	Circular auto averaging, 2 readings are averaged. Display updates 20 times a second.
C4	Circular auto averaging, 4 readings are averaged. Display updates 10 times a second.
C8	Circular auto averaging, 8 readings are averaged. Display updates 5 times a second.
C16	Circular auto averaging, 16 readings are averaged. Display updates 3 times a second.
C32	Circular auto averaging, 32 readings are averaged. Display updates 1½ times a second.
C64	Circular auto averaging, 64 readings are averaged. Display updates 1 time every 1.4 seconds.

NOTE: On the Circular auto averaging filter, when in motion only 4 readings are averaged.

Automatic Zero Tracking Setup Menu

AZt	Automatic Zero Tracking Range Small weights within the specified number of divisions are automatically zeroed.
OFF	Zero tracking is off. No automatic zeroing.
0.5	Zero tracking to within 0.5 division.
1*	Zero tracking to within 1.0 division.
3*	Zero tracking to within 3.0 divisions.
5*	Zero tracking to within 5.0 divisions.

* **NOTE:** The Legal for Trade mode disables some options and selections listed above. These items have been indicated by an asterisk.

Motion Aperture Setup Menu

nn.R.*	Motion aperture * Determines how many divisions consecutive readings must change before the scale is considered in motion.
0.5	0.5 division change must be seen to enter motion.
1	1 division change must be seen to enter motion.
3	3 division change must be seen to enter motion.
5	5 division change must be seen to enter motion.
10	10 division change must be seen to enter motion.

Start Up Zero Setup Menu

SV0*	Start Up Zero Controls the start up zero status.
on	Zeros on the first stable reading on power up.
CL0	Loads the calibration zero for zero reference
Pb0*	Loads the last pushbutton zero. (Disabled in LFT mode)

Latching Zero Request Setup Menu

Zod	Zero on Demand Enables or disable zero latching.
on	If ZERO is pressed, it is saved until the scale becomes stable.
off	If the scale is in motion, the zero request is discarded.

Latching Print Request Setup Menu

Pod	Print on Demand Enables or disables print latching.
on	If PRINT is pressed, the print request is saved until the scale becomes stable.
off	If the scale is in motion, the print request is discarded.

* **NOTE:** The Legal for Trade mode disables some options and selections listed above. These items have been indicated by an asterisk.

Printer Data Output Setup Menu

d.o.	Data Output Mode (see Print Modes) Determines when serial data will be sent.
t.o.d.	Transmit on demand. Print when the PRINT button is pressed.
A.P.1	Auto Print 1. Print once only when scale goes stable.
A.P.2	Auto Print 2. Print once only when scale goes stable. Scale must return to a negative weight or within the adjustable threshold level, before it can print again. (see Threshold Level Menu)
A.P.3	Auto Print 3. Print once only when scale goes stable within the accept band. Scale must return to a negative weight or within the adjustable threshold level, before it can print again. (see Threshold Level Menu)
C.P.	Continuous Print. Print when display is updated. (Disabled in RS485 mode)

Output Formats

For.	Data Input / Output Format (see Data output format) Defines the appearance of the serial data sent.
F0	Basic output format (8,n,1)
F1	Enhanced output includes checkweigh status.
2d	Basic Dual Print Format. Includes Kilogram weight.
55P	Basic Output for Eltron printer
F9	Model 8000 emulation
UPS	UPS World Ship format (7,o,2)(9600 baud)
d3	Live Scale (Virtual) Display format (set d.o. to C.P.)
Lb1	Select label buffer 1 (user defined print string)
Lb2	Select label buffer 2 (user defined print string)
Lb3	Select label buffer 3 (user defined print string) (Used for data collection with Comma-delimited format / CSV)
Lb4	Select label buffer 4 (user defined print string) (Used for Accumulator / Counter Print Command)
t1d	Toledo PS60 format. (7,o,2)
nc1	NCI 3825 format (7,e,1)(4800 baud)
nc2	NCI 3835 format (7,e,1)(4800 baud)

Baud Rate Setup Menu

br.	Baud Rate Setup Determines baud rate for serial data.
12	1200 baud (bits per second)
24	2400 baud (bits per second)
48	4800 baud (bits per second)
96	9600 baud (bits per second)
14.4	14,400 baud (bits per second)

Serial Data Handshaking Setup Menu

85	Serial Data Output Handshaking Selects the type of serial data handshaking used. (See the Data Communication section for details)
5F	Software handshaking. Data is sent when ready. Transmission can be controlled by the receiving device. The software handshaking option activates Bi-directional RS232 communications. Refer to the communications section for details.
0FF	No handshaking is used. Data is sent when ready, receiving device (printer) must be fast enough to keep up with the data. Disables bi-directional communications.
8dd	Turns on Address mode. (All received serial commands require a 00-99 address preface.)
485	Turns on RS485 mode, print buffer & Address mode (Disabled when Data Output is set for Continuous Print) (See RS485 Communications for details.)

Scale Address (Scale ID number)

Addr	Selects scale (bus) address code. An two digit ASCII number is required before scale will respond to any serial input. (See RS485 Communications for details)
0-99	Press zero pb to scroll address from 0 through to 99

Units Conversion Setup Menu

C5L	Convert Select Modes Determines which units selections will be active.
no	Do not enter Convert selection menu.
4E5	Enter Convert selection menu.
	Lb pounds menu
	on lb is active
	0FF lb is non active
	kg kilograms menu
	on kg is active
	0FF kg is non active
	oz ounces menu
	on oz is active
	0FF oz is non active
	gr grams menu
	on g is active
	0FF g is non active
	Lo* pound-ounces menu (Disabled in LFT mode)
	on* lb-oz is active
0FF* lb-oz is non active	

* **NOTE:** The Legal for Trade mode disables some options and selections listed above. These items have been indicated by an asterisk.

Start Up Units Selection Menu

0n 155	Start Up Units Select Mode Configures selection of start up units.
	Press ZERO to scroll through the units activated in the Units parameter. The selected units will be displayed on the units indicators to the right of the display.

NOTE: If an invalid start up unit is selected for a given capacity, the scale will automatically change the unit setting to the next a valid unit.

Push-button Function Setup Menu

P.b.	Push Buttons Configures the active push button functions.	
no	Do not enter push button selection menu.	
555	Enter push button selection menu.	
	Acc	ACCUM (Hidden) push button menu
	on	pb is active
	off	pb is non active
	OU	OVER & UNDER push button menu
	on	pb is active
	off	pb is non active
	Pr	PRINT push button menu
	on	pb is active
	off	pb is non active
	Ut	UNITS push button menu
	on	pb is active
	off	pb is non active
	Zr	ZERO push button menu
	on	pb is active
	off	pb is non active
	rt	REMOTE push button menu (connector P2, pins 3 & 4)
	off	Remote pb is non active
	Zr	Remote pb = ZERO pb
	Pr	Remote pb = PRINT pb
	Ut	Remote pb = UNITS pb
Acc	Remote pb = ACCUM pb	

Operating mode Setup Menu

OP *	Operating mode Activates the Legal for Trade mode.
5td	Standard operation (Audit Trail)
44	Legal for Trade, Handbook 44 (NIST) (Audit Trail, Audit counters shown)
445	Legal for Trade Switch mode, Handbook 44 (NIST) and Measurement Canada compliant. (Front Panel Cal Access feature disabled, Cal Switch entry only, Audit counters hidden)
PH	Peak and hold stable or non stable weight.
PHt	Peak and hold for 2 seconds, stable or non stable weight.
PH5	Peak and hold only stable weight.
PHt	Peak and hold for 2 seconds, only stable weight.
95t	Grade and show weight. The positive or negative weight differences between two stable weights is momentarily shown for 2 seconds. Note: Check Weighing Operation (t.d.) is automatically set to Setpoint Operation mode (5tR). Press UNITS button to toggle between Grading and one weighing unit as defined by the startup unit parameter.
9nt	Grade and show grade number. The grade number (i.e. "000000" to "888888") that was activated from the positive or negative weight differences between two stable weights is momentarily shown for 2 seconds. Note: Check Weighing Operation (t.d.) is automatically set to Setpoint Operation mode (5tR). Press UNITS button to toggle between Grading and one weighing unit as defined by the startup unit parameter.

* **NOTE:** The Legal for Trade mode disables some options and selections listed above. These items have been indicated by an asterisk.

Unit On Timer (Battery option only)

t dY	Selects the time value that the unit will remain on
on	Unit will remain on, On timer is off
0.5	30 second "On timer"
1	1 minute "On timer"
1.5	1.5 minutes "On timer"
2	2 minutes "On timer"
3	3 minutes "On timer"
5	5 minutes "On timer"
10	10 minutes "On timer"
30	30 minutes "On timer"

NOTE: The "On Timer" governs the amount of time the unit stays on after ON/ZERO is pressed. The electronics in the scale sense activity on the scale platform - when there is no activity on the platform within the time programmed for the "On Timer", the unit will turn itself off. Each time there is activity (motion) on the scale's platform or any pushbutton activity before the scale turns off, the "On Timer" is reset to its full time period.

Checkweighing Operation Menu

Code	Check Weighing Operation Configures the check weighing operating mode.
oFF	Check weighing off (7000XL, 8000XL mode)
oUR	Over, Accept and Under 3 band check weighing. (4300 mode) Output Active: All time
oUS	Over, Accept and Under 3 band check weighing. (4300 mode) Output Active: only stable weights (Note: Setpoints 1-3 Output Active: All time)
oUt	Over, Accept and Under 3 band check weighing. (4300 mode) Output Active: only weights above Threshold level. (Note: Setpoints 1-3 Output Active: All time)
oUt	Over (Latching), Accept and Under 3 band check weighing. (4300 mode) Output Active: only weights above Threshold level. Over output will latch until weight is below the threshold level. (Note: Setpoints 1-3 Output Active: All time)
oUb	Over, Accept and Under 3 band check weighing. (4300 mode) Output Active: only stable weights above Threshold level. (Note: Setpoints 1-3 Output Active: All time)
oUb	Over (Latching), Accept and Under 3 band check weighing. (4300 mode) Output Active: only stable weights above Threshold level. Over output will latch until weight is below the threshold level. (Note: Setpoints 1-3 Output Active: All time)
5bR	High, Over, Accept, Under & Low 5 band check weighing. (4300 mode) Output Active: All time (Note: Setpoints 1-3 Output Active: All time)
5bS	High, Over, Accept, Under & Low 5 band check weighing. (4300 mode) Output Active: only stable weights (Note: Setpoints 1-3 Output Active: All time)
5bU	High, Over, Accept, Under & Low 5 band check weighing. (4300 mode) Output Active: only weights above Threshold level. (Note: Setpoints 1-3 Output Active: All time)
5bb	High, Over, Accept, Under & Low 5 band check weighing. (4300 mode) Output Active: only stable weights above Threshold level. (Note: Setpoints 1-3 Output Active: All time)
b nR	Zero Band check weighing (7400 mode) Output Active: All time (Note: Setpoints 1-3 Output Active: All time)
b nS	Zero Band check weighing (7400 mode) Output Active: only stable weights (Note: Setpoints 1-3 Output Active: All time)
5ER	Setpoint operation mode, all outputs configured as setpoints (4300 mode) Output Active: All time.
5ES	Setpoint operation mode, all outputs configured as setpoints (4300 mode) Output Active: only stable weights.

Setpoint & Checkweight Entry Menu

5.5.	Setpoint and Checkweight Entry Adjust individual Setpoint & Checkweight levels.	
no	Do not enter Setpoint & Checkweight entry menu.	
555	Enter to selected and adjust individual weight entry menu.	
	SP1 RJ	Setpoint 1 entry menu
		xxxxxx use print and hidden push button to scroll value.
	SP2 RJ	Setpoint 2 entry menu
		xxxxxx use print and hidden push button to scroll value.
	SP3 RJ	Setpoint 3 entry menu
		xxxxxx use print and hidden push button to scroll value.
	Lo (SP4) RJ	Low Under (Setpoint 4) entry menu ^{1,2,3}
		xxxxxx use print and hidden push button to scroll value.
	udr (SP5) RJ	Under (Setpoint 5) entry menu ^{1,3}
		xxxxxx use print and hidden push button to scroll value.
	SP6 RJ	Setpoint 6 entry menu (Accept) ^{2,3}
		xxxxxx use print and hidden push button to scroll value.
	oUr (SP7) RJ	Over (Setpoint 7) entry menu ^{1,3}
		xxxxxx use print and hidden push button to scroll value.
	H. (SP8) RJ	High Over (Setpoint 8) entry menu ^{1,2,3}
		xxxxxx use print and hidden push button to scroll value.

¹ Configured for setpoint operation when parameter Checkweighing Operation C.o. is set to SEA or SES mode.

² Disabled when parameter Checkweighing Operation C.o. is set to oUA, oUS, oUt, oUb mode. (3 Band Checkweighing)

³ Disabled when parameter Checkweighing Operation C.o. is set to bnA, bnS mode. (Zero Band Checkweighing)

Threshold Level Menu

TH5	Threshold Level Entry Selects a percent threshold of Capacity when AP2 and Check Weighing operation is active.
0.1 - 9.9	$\pm 0.1\%$ to $\pm 9.9\%$ of capacity. Default setting is 1%

Checklimit Entry Mode Menu (4300 mode only)*

C.E.	Checklimit Entry Selects the limit entry mode for check limits.
Pb	Push to enter current platform weight.
5Cr	Use OVER and UNDER buttons to scroll saved weight up or down to desired value.
5CS	Use OVER and UNDER buttons to scroll current platform weight up or down to desired value.

* Checklimit Entry Mode Menu disabled when parameter $\bar{L}.o.$ is set to off.

Over and Under Band Setup Menu (7400 mode only)

0.0.	Over and Under tolerances menu allows the selection of zero band check weighing in scale divisions.
oFF	Band limit check weighing is off.
1	+1 division
2	+2 division
3	+3 division
4	+4 division
5	+5 division
7	+7 division
10	+10 division
15	+15 division
20	+20 division
30	+30 division

Default all Scale Parameter settings

dEft	Default Calibration and Parameter settings.	
n	Do not default settings.	
y	1 st yes answer, Default all Calibration and Parameter settings	
	n	Do not default settings
	y	Verify 2 nd yes answer, Default all Calibration and Parameter settings

WARNING: Defaulting the scale will require recalibration.

ISP Mode

ISP	In System Programming Mode. (Factory use only)	
n	Do not enter ISP mode.	
y	1 st yes answer, to entering in ISP mode	
	n	Do not enter ISP mode
	y	Verify 2 nd yes answer, Scale enters ISP mode.

Test Mode Menu

	Test mode menu Press Zero button to enter Test mode menu or Units to bypass menu.	
xxxxxx	Displays the raw counts from Analog to Digital converter.	
4nnnR	Set 4-20mA analog output to a 4 mA level. Press Zero or Hidden push button to adjust 4mA output level.	
	4R XX	Press Zero pb to adjust 4mA level and Units pb to exit.
20nnnR	Set 4-20mA analog output to a 4 mA level. Press Zero or Hidden pb to adjust 4mA output level.	
	20R XX	Press Zero pb to adjust 20mA level and Units pb to exit.
out 1	Activate Output 1 on Digital Output option board. Press Zero pb to select the type of logic options for Output 1. Use Units pb to scroll to the next Output parameter.	
	o 1 oFF	No output logic, Output 1 is turned off.
	o 1 SP1	Setpoint 1 used for output logic. (default)
	o 1 SP2	Setpoint 2 used for output logic.
	o 1 SP3	Setpoint 3 used for output logic.
	o 1 Lo (SP4)	Low Under (Setpoint 4) used for output logic.
	o 1 udr (SP5)	Under (Setpoint 5) used for output logic.
	o 1 Ac (SP6)	Accept (Setpoint 6) used for output logic.
	o 1 over (SP7)	Over (Setpoint 7) used for output logic.
	o 1 h. (SP8)	High Over (Setpoint 8) used for output logic.
	o 1 Er	Scale Error Message used for output logic.
	o 1 tHr	Weight below threshold level used for output logic.
out 2	Activate Output 2 on option board. Press Zero pb to select output logic.	
	o 1 SP2	Setpoint 2 used for output logic. (default)
out 3	Activate Output 3 on option board. Press Zero pb to select output logic.	
	o 1 SP3	Setpoint 3 used for output logic. (default)
out 4	Activate Output 4 on option board. Press Zero pb to select output logic.	
	o 1 Lo (SP4)	Low Under (Setpoint 4) used for output logic. (default)
out 5	Activate Output 5 on option board. Press Zero pb to select output logic.	
	o 1 udr (SP5)	Under (Setpoint 5) used for output logic. (default)
out 6	Activate Output 6 on option board. Press Zero pb to select output logic.	
	o 1 Ac (SP6)	Accept (Setpoint 6) used for output logic. (default)
out 7	Activate Output 7 on option board. Press Zero pb to select output logic.	
	o 1 over (SP7)	Over (Setpoint 7) used for output logic. (default)
out 8	Activate Output 8 on option board. Press Zero pb to select output logic.	
	o 1 H. (SP8)	High Over (Setpoint 8) used for output logic. (default)

Calibration and Parameter Menu Exit

done	Exit Calibration and Parameter Menu.
n	Do not exit menu. roll over to the start of the parameter list.
y	Exit Calibration and Parameter menu. Save all parameter changes. The scale will return to normal weighing when UNITS is pressed.

Data Communications

Introduction to data communications:

The scale data is sent to a printer or computer by using "asynchronous serial data communications." Data is broken up and sent one piece at a time to the printer or computer. In spite of this apparent simplicity, a basic understanding of serial data communications is needed when setting up the scale.

The scale transmits letters and numbers to a printer or computer by replacing the letter (or number) with an eight bit ASCII code. This code is then transmitted, one bit at a time, to a printer or a computer. A bit is the smallest unit of data and can have a value of "1" or "0." By combining eight bits into a byte, it is possible to get 256 unique bit patterns. These patterns are used to create the ASCII codes used by the scale to represent letters and numbers.

When setting up a serial communications system, there are several concerns which affect the configuration of that system. These are:

- transmission rate
- knowing when data starts and stops
- the ability of the receiving equipment to digest the data sent

The transmission rate determines how fast the data is sent from the scale to the printer (or computer) and is measured in Baud or bits per second. (Baud and bits per second are interchangeable.) The transmission rate controls how many bits can be sent in a given time. It is important that the sending and receiving units are set to the same Baud settings. Typical values are 1200, 2400, 4800 and 9600 baud.

The term "asynchronous serial data communications" implies that the sending unit has no way of telling the receiving unit when a data bit has been sent or when to expect the next bit. To correct this problem, both the sending and receiving units use the baud rate setting to determine how fast data should be sent. If the baud rates at the sending and receiving units differ, the receiving unit will expect data to arrive at a different time than when the transmitting unit sent it. When this happens, data will be lost. When the baud rates match, the receiving unit has no problem with the data arriving early or late. The only problem is knowing when the data transmission started.

The scale and the equipment connected to it resolve this dilemma by sending a "start bit" at the beginning of each data byte. This bit tells the printer or computer that a new data byte is on the way. When the start bit is received, the bit timer starts running and runs until it has received the correct number of bits.

The number of bits sent by the scale is controlled by the data bits, parity and stop bit configuration. The scale is factory set for eight bits, no parity and one stop bit. This means that the eight bits following the start bit will be data, followed by a stop bit. The stop bit signals the end of the data and permits the bit timer a chance to reset itself before the next data byte is sent. No parity bits are sent.

In many cases, the receiving unit is a slow printer with limited memory. In these cases, more data may be sent than the printer can use. Again, data may become lost or scrambled. To prevent this from happening, "Handshaking" is used. When the receiving unit is busy or incapable of receiving further data, it activates the handshaking; telling the sending unit to stop transmission. Then, whenever the receiving unit is ready for more data, it deactivates the handshaking and data transmission continues.

The scale offers hardware and software handshaking. Hardware handshaking makes use of the CTS (clear to send) input on the unit. When this signal is active, the scale is permitted to send data. When the receiving unit is busy, the CTS line is deactivated and the scale stops sending data. When the receiving unit is ready for more data, the CTS is reactivated and the scale will finish sending the data string it was sending when transmission was interrupted. All readings created while transmission is halted are discarded.

Software handshaking relies on bi-directional communications to send the XON (Ctrl-Q) and XOFF (Ctrl-S) flow control characters. The scale has limited bi-directional serial communications to support software handshaking. When a "Ctrl-S" is received, the transmission of data is halted until a "Ctrl-Q" is received. To use this mode, the RTX line of the scale is tied to the TXD line of the receiving unit. Refer to Doran RS-232 Training Technical Bulletin (MAN0214) for in depth coverage of this subject.

Printer Modes:

The Scale Indicator offers four different print control modes. These modes dictate when printer data is sent. To confirm data has been sent, the display will show a "r" to confirm data transmission.

Transmit on demand (t o d):

In this mode, scale data is transmitted whenever the PRINT button is pressed, the remote PRINT button is pressed, or a print request is received from the serial port. The scale must be stable and the scale value must be valid before the data is printed.

Continuous print (c p):

In continuous print, data is transmitted each time the scale has a reading ready. Readings which occur when the scale is in motion are called out by the abbreviation "MOT." following the data. The Digital Filter Setup parameter will control the number of data transmissions per second.

Auto Print 1 (A P 1):

Auto Print 1 transmits the first scale reading after the scale leaves motion. The reading must be stable and must be a valid reading before it can be sent.

Auto Print 2 (A P 2):

Auto Print 2 transmits the first scale reading following the scale leaving motion and above the adjustable threshold level. To adjust the Threshold level as a % of capacity, see the Threshold Level parameter. In Auto Print 2, no further readings will be sent until the scale returns to weight reading that is below the adjustable threshold level. The reading must be stable and must be a valid reading before it can be sent.

Auto Print 3 (RP3):

Auto Print 3 transmits the first scale reading following the scale leaving motion, being above the adjustable threshold level and in the accept band. To adjust the Threshold level as a % of capacity, see the Threshold Level parameter. In Auto Print 3, no further readings will be sent until the scale returns to weight reading that is below the adjustable threshold level. The reading must be stable, in the accept band, and must be a valid reading before it can be sent.

Data output format:

In order for the serial data sent from the scale to be useful, the data must be organized so that it is easy to read. To accomplish this, the scale arranges the displayed data with additional text to indicate the active units and to indicate the presence of motion during the reading.

"F0" Format:

The basic data format sent by the scale is illustrated in Table 2. Each line of data begins with an STX character (start of text) followed by a polarity sign, which indicates the reading polarity. Next, the displayed data is sent. Six digits are used with a decimal point inserted in the correct position. After the weight data is sent, a space followed by the units are added to the string. When motion is present, another space is inserted followed by "MOT." The string is then finished by adding a carriage return and a line feed.

In the case of lb-oz data, the pounds value is placed after the polarity sign. A space followed by "lb" and another space follows the pounds data. Ounce data is then sent with a decimal point inserted where needed. Once again a space is inserted after the weight data followed by "oz." Only six digits are sent in the lb-oz mode so the allocation of these digits depends on the ounces resolution. Refer to Table 2 for details.

"2d" Format:

In the "DUAL PRINT" format, the current weight is first printed using the "F0" format. Then the weight is recalculated in kilograms and is sent as a second line of text. The kilogram data follows the "F0" data format except where parentheses are placed after the STX character and before the carriage return, line feed. Refer to Table 2 for details.

"SSP" format:

The data string produced by the SSP format allows the scale to communicate with an Eltron Label Printer. This printer allows the creation of custom labels containing weight information, bar codes and graphics. Refer to Table 2 for details.

"F9" Format:

In the "8000 emulation" format, the print string is the same as the "F0" format. The only difference is that "grs" message is add between the current units <uu> and the motion <MOT> status. Refer to Table 2 for details.

"UP5" Format:

The data string produced by the UPS format allows the scale to communicate with an UPS world ship program. Refer to Application Note at end of manual and Table 2 for details.

"d3" Format:

The data string produced by the d3 format allows the scale to communicate with a Live Scale (Virtual) Display portion of the Dimension software that is running on a computer. Note: that parameter d.o. should be set for continuous print "C.P." for the program to function properly. See Dimension Software Section.

"Lb1 - Lb4" Format:

Label Buffer 1 through 4, is a user configurable print string. Note: scale is already preprogrammed with a default print strings loaded into each label buffer. Label Buffer 3 is used for data collection and is configured with a comma-delimited format or CSV (comma-separated values). Label Buffer 4 is used for Accumulator print feature. Refer to Label Buffer Configuration on following page for details.

Print String Formatting:

The Scale provides eight predefined print strings that are outputted when a manual print, auto print or print function is executed. The Label Buffer print string provides the opportunity to define a custom print string up to 64 characters in length. The exact contents of the predefined print strings and Label Buffer print string configuration is shown below.

	Print String	Description
F0	Standard Output Format, Prints current weight and units. <STX><p><xxxx.xx><SP><uu><SP> <MOT><CR><LF> Sample Print String ±--10.05-lb Sample Pounds – Ounces String ±27lb-12.2-oz Note: "-" represents a space	<STX> Start of Text (02h) <p> Weight Polarity Negative weight printed as "-", positive weight are printed as a space (20h). <xxxx.xx> Weight Data fixed field of 6 digits plus decimal. In overload, or underload "-----" is printed. Leading zeros are printed as spaces (20h). <uu> Displayed Units "lb", "kg", "oz", "g", "lb:oz" <MOT> (Available only in Continuous print mode , non-LFT) Motion Status Appends "MOT" to the print string when printing while in motion. <SP> Line Space (20h) <CR> Carriage Return (0dh) <LF> Line Feed (0Ah)
2d	Dual Print Output Format, Prints	<STX> Start of Text (02h)

	<p>current and kg weight resolution.</p> <p><STX><p><xxxx.xx><SP><uu><SP> <MOT><CR><LF> <()><p><xxxx.xx><SP><kg><SP><()><MOT><CR><LF></p> <p>Sample Print String ±--10.05-lb ±---4.56-kg</p> <p>Note: "-" represents a space</p>	<p><p> Weight Polarity Negative weight printed as "-", positive weight are printed as a space (20h). <xxxx.xx> Weight Data fixed field of 6 digits plus decimal. In overload, or underload "-----" is printed. Leading zeros are printed as spaces (20h). <uu> Displayed Units "lb", "kg", "oz", "g", "lb:oz" <MOT> (Available only in Continuous print mode , non-LFT) Motion Status Appends "MOT" to the print string when printing while in motion. <SP> Line Space (20h) <CR> Carriage Return (0dh) <LF> Line Feed (0Ah)</p>
<p>55P</p>	<p>Label Printer Output Format, for Eltron printers</p> <p><FR"L1"><LF><?><LF><p><xxxx.xx><LF> ><uu><LF><"GS"><LF><MOT><LF><p> <xxxx.xx><LF><kg><LF><P1,1><LF></p> <p>Sample Print String FR"L1" ? ±--10.05 lb GS MOT ±---4.56 kg P1,1</p> <p>Note: "-" represents a space</p>	<p><p> Weight Polarity Negative weight printed as "-", positive weight are printed as a space (20h). <xxxx.xx> Weight Data fixed field of 6 digits plus decimal. In overload, or underload "-----" is printed. Leading zeros are printed as spaces (20h). <uu> Displayed Units "lb", "kg", "oz", "g", "lb:oz" <MOT> (Available only in Continuous print mode , non-LFT) Motion Status Appends "MOT" to the print string when printing while in motion. <SP> Line Space (20h) <CR> Carriage Return (0dh) <LF> Line Feed (0Ah)</p>
<p>F9</p>	<p>8000 emulation format, Prints current weight, units, and "grs".</p> <p><STX><p><xxxx.xx><SP><uu><SP><grs> ><MOT><CR><LF></p> <p>Sample Print String ±--10.05-lb-grs</p> <p>Note: "-" represents a space</p>	<p><STX> Start of Text (02h) <p> Weight Polarity Negative weight printed as "-", positive weight are printed as a space (20h). <xxxx.xx> Weight Data fixed field of 6 digits plus decimal. In overload, or underload "-----" is printed. Leading zeros are printed as spaces (20h). <uu> Displayed Units "lb", "kg", "oz", "g", "lb:oz"</p>

		<p><MOT> (Available only in Continuous print mode , non-LFT) Motion Status Appends "MOT" to the print string when printing while in motion.</p> <p><SP> Line Space (20h)</p> <p><CR> Carriage Return (0dh)</p> <p><LF> Line Feed (0Ah)</p>
<p>d3</p>	<p>Live Scale (Virtual) Display format, Prints current weight, units, annunciators, checkweight status, and output status.</p> <p><"^"><p><xxxx.xx><ut><an><chk1-4><chk5-8><out1-4><out5-8><ETX></p> <p>Sample Print String ±--10.05000000</p> <p>Note: "-" represents a space</p>	<p><"^"> caret (5Eh)</p> <p><p> Weight Polarity Negative weight printed as "-", positive weight are printed as a space (20h).</p> <p><xxxx.xx> Weight Data fixed field of 6 digits plus decimal. In overload, or underload "-----" is printed. Leading zeros are printed as spaces (20h).</p> <p><ut> Displayed Units lb = 0(30h), kg = 1(31h), oz = 2(32h), g = 3(33h), lb:oz = 4(34h)</p> <p><an> Annunciators all off = 0(30h), all on =?(37h) ZERO = bit 0 BATT = bit 1 MOT = bit 2</p> <p><chk1-4> Checkweight status Setpoints 1-4. all off = 0(30h), all on =?(3fh) Setpt 1 = bit 0 Setpt 2 = bit 1 Setpt 3 = bit 2 Setpt 4(Low) = bit 3</p> <p><chk5-8> Checkweight status Setpoints 5-8. all off = 0(30h), all on =?(3fh) Setpt 5(Under) = bit 0 Setpt 6(Accept) = bit 1 Setpt 7(Over) = bit 2 Setpt 8(High) = bit 3</p> <p><out1-4> Output status 1-4 all off = 0(30h), all on =?(3fh) out 1 = bit 0 out 2 = bit 1 out 3 = bit 2 out 4 = bit 3</p> <p><out5-8> Output status 5-8 all off = 0(30h), all on =?(3fh) out 5 = bit 0 out 6 = bit 1</p>

		<p>out 7 = bit 2 out 8 = bit 3 <ETX> End of Text (03h)</p>
<p>1b1</p>	<p>Label Buffer 1 (\x\w \u \m\r\l)</p> <p><STX><p><xxxx.xx><SP><uu><SP> <MOT><CR><LF></p> <p>Sample Print String ±--10.05-lb</p> <p>Note: "-" represents a space</p>	<p><STX> Start of Text (02h) <p> Weight Polarity Negative weight printed as "-", positive weight are printed as a space (20h). <xxxx.xx> Weight Data fixed field of 6 digits plus decimal. In overload, or underload "-----" is printed. Leading zeros are printed as spaces (20h). <uu> Displayed Units "lb", "kg", "oz", "g", "lb:oz" <MOT> (Available only in Continuous print mode , non-LFT) Motion Status Appends "MOT" to the print string when printing while in motion. <SP> Line Space (20h) <CR> Carriage Return (0dh) <LF> Line Feed (0Ah)</p>
<p>1b2</p>	<p>Label Buffer 2 (\x\w \u \m\r\l)</p> <p><STX><p><xxxx.xx><SP><uu><SP> <CWS><MOT><CR><LF></p> <p>Sample Print String ±--10.05-lb-ACCEPT</p> <p>Note: "-" represents a space</p>	<p><STX> Start of Text (02h) <p> Weight Polarity Negative weight printed as "-", positive weight are printed as a space (20h). <xxxx.xx> Weight Data fixed field of 6 digits plus decimal. In overload, or underload "-----" is printed. Leading zeros are printed as spaces (20h). <uu> Displayed Units "lb", "kg", "oz", "g", "lb:oz" <MOT> (Available only in Continuous print mode , non-LFT) Motion Status Appends "MOT" to the print string when printing while in motion. <SP> Line Space (20h) <CR> Carriage Return (0dh) <LF> Line Feed (0Ah) <CWS> Check Weight status. "HIGH ", "OVER ", "ACCEPT", "UNDER ", "LOW ", and " "</p>

<p>1b3</p>	<p>Comma-delimited format / CSV</p> <p>Label Buffer 3 (\w,\u,\i\r\l)</p> <p><p><xxxx.xx><","><uu><","><ADR> <CR><LF></p> <p>Sample Print String ±--10.05,lb,00</p> <p>Note: "-" represents a space</p>	<p><p> Weight Polarity Negative weight printed as "-", positive weight are printed as a space (20h). <xxxx.xx> Weight Data fixed field of 6 digits plus decimal. In overload, or underload "-----" is printed. Leading zeros are printed as spaces (20h). <","> Comma (02ch) <uu> Displayed Units "lb", "kg", "oz", "g", "lb:oz" <ADR> Scale Address(ASCII 00- 99) <CR> Carriage Return (0dh) <LF> Line Feed (0Ah)</p>
<p>1b4</p>	<p>Accumulator print feature.</p> <p>Label Buffer 4 (\xACC:\a \u\r\CNT: \c\r\B)</p> <p><STX><"ACC:"><ACC><SP><uu><CR> <LF><"CNT:"><CNT><CR><LF></p> <p>Sample Print String ACC:---0.00-lb CNT:-----0</p> <p>Note: "-" represents a space</p>	<p><STX> Start of Text (02h) <p> Weight Polarity Negative weight printed as "-", positive weight are printed as a space (20h). <xxxx.xx> Weight Data fixed field of 6 digits plus decimal. In overload, or underload "-----" is printed. Leading zeros are printed as spaces (20h). <uu> Displayed Units "lb", "kg", "oz", "g", "lb:oz" <MOT> (Available only in Continuous print mode , non-LFT) Motion Status Appends "MOT" to the print string when printing while in motion. <SP> Line Space (20h) <CR> Carriage Return (0dh) <LF> Line Feed (0Ah) <ACC> Accumulator weight data (fixed field of 6 digits plus decimal Leading zeros are printed as spaces (20h). <CNT> Counter value "000000" to "999999"</p>

Label Buffer Configuration

Programming the Label Buffer print string requires the use of a PC terminal program and the Serial cable option. To program the indicator for a custom print string, match the terminal program and the indicator communications parameters. Confirm the system communications by typing a Z and pressing ENTER. The scale display should zero. If this does not occur, check the hand shaking settings and cable configuration.

To configure the Label Buffer Print strings, simply type the print commands into the terminal and press enter. The label buffer control characters are as follows:

\a	Accumulated Weight (6 digits +dp)	\s	Check Weight Status ("HIGH ", "OVER ", "ACCEPT", "UNDER ", "LOW ", and " ") or ("0", "1", "2", "3", "4", "5", "6", "7", and "8")
\c	Accumulation Counter (6 digits +dp)	\u	Current Units ("lb", "kg", "oz", "g", "lb:oz")
\w	Current Weight (6 digits +dp)	\m	Motion Status ("MOT" or " ") (works in continuous print mode only)
\p	Weight in pounds (6 digits +dp)	\\	Print "\
\k	Weight in kilograms (6 digits +dp)	\l	Line Feed (0a hex)
\g	Weight in grams (6 digits +dp)	\r	Carriage Return (0d hex)
\o	Weight in ounces (6 digits +dp)	\i	Scale Address (00-99)
\z	Weight in lb-oz (6 digits +dp)	\x	Start of Text (02 hex)
\hxx	Hex command two digits (xx = hex #)	\B	Clears Accumulator & Counter
		\Z	Zero scale (same as pressing zero pb)

Plain text can be inserted into the print string by just typing it in. No slash or control character is necessary.

To download a Label Buffer Print string the string must be prefaced by a command to tell the indicator to expect a custom print string.

ELx<string>↵ Enter (Download) Label Buffer Print String.

RLx↵ Read (Upload) Label Buffer Print String.

x is the label buffer number (1 to 4)

↵ is CR or enter key in terminal program

The label buffer is limited to 62-character string length. Therefore, a control character counts as two characters. The following string is 8 characters in length "\w\u\r\l". The custom string is terminated and download by pressing the enter (↵) key. To program this string for Label Buffer 1 location in scale's memory, send the following string:

EL1\w\u\r\l↵

Once programmed, set the Output Format "F0r" parameter to 1b1 to active the print string.

Note: If the PRINT button is pressed while the accumulator or counter is displayed. Label buffer 4 is transmitted instead of the configured print string option for the Output Format.

Label Buffer Default settings

The indicator is shipped with all the label buffers preloaded with print strings. The following strings are stored in each of the individual buffers.

Label Buffer 1: “\x\w \u \m\r\l”

Label Buffer 2: “\x\w \u \s\m\r\l”

Label Buffer 3: “\w,\u,\i\r\l”

Label Buffer 4: “\xACC:\a \u\r\l\CNT: \c\r\l\B”

Remote Setpoint Entry and Recall:

To download a Check Weight (i.e. Setpoint value) the serial string must be prefaced by a command to tell the indicator to expect a setpoint weight value.

ESx<string>↵ Enter (Download) Setpoint Weight value.

RSx↵ Read (Upload) Setpoint Weight value.

x is the label buffer number (1 to 8)

Note: High = Setpoint 8, Over = Setpoint 7, Under = Setpoint 5, Low = Setpoint 4.

↵ is CR or enter key in terminal program.

A command counts as three characters. If needed, a negative polarity "-" character is prefix to the weight value. Note: Do not place a space between the negative sign and the weight value. Up to six digits, plus decimal point for weight value can be entered. The following string is 6 characters in length “20.000”. The entry string is terminated and download by pressing the enter (↵) key. To enter a weight value of 20 lbs. for Setpoint 7 (Over limit) in scale’s memory, send the following string: ES720.000↵. To enter in a -1 lbs. for Setpoint 5 (Under limit), send the following string: ES5-1.000↵. Note: The decimal point location and count-by resolution for the weight being entered, must match the scale’s front display format. A “5 0 0 0 0 0” message will momentarily show on the scale’s front display, to indication that the setpoint value has been successfully saved to non-volatile memory. An entry error will be indicated by a “?” character returned on the serial port.

Command (RXD)	Scale output Response (TXD)	Description
<p>W or w (hex 57, hex 77)</p>	<p><STX><p><xxxx.xx><SP><uu><SP><MOT><CR><LF> or <STX><p><xxxx.xx><SP><uu><SP><MOT><CR><LF> <(><p><xxxx.xx><SP><kg><SP>< ><MOT><CR><LF> or <FR"L1"><LF><?><LF><p><xxxx.xx><LF><uu><LF> <GS><LF><MOT><LF><p><xxxx.xx><LF><kg><LF><P1,1><LF> or <STX><p><xxxx.xx><SP><uu><SP><grs><MOT><CR><LF></p>	<p>“_F0” standard format, Prints current weight and units. “_2d” dual print format, Prints current and kg weight resolution. “55P” Label printer format, for Eltron printers “_F9” 8000 emulation format, Prints current weight, units, and “grs”. <xxxx.xx> weight data (fixed field of 6 digits plus decimal or “-----” for overload, underload, gross underload, or gross overload) <p> polarity “-” or “ “ <GS> gross or net status (always “GS”) <uu> current units (“lb”, “kg”, “oz”, “g”) <SP> line space (hex 20) <MOT> motion status (“MOT.” or “ “) <CR> carriage return (hex 0D) (control-M) <LF> line feed (hex 0A) (control-J)</p>
<p>U or u (hex 55, hex 75)</p>		<p>Scale changes current units</p>
<p>Z (hex 5A, hex 7A)</p>		<p>Zeros scale</p>
<p>XON (hex 11, ctrl-Q)</p>		<p>Turns on serial handshaking, Scale output disabled (available only when Parameter H5 = 5F)</p>
<p>XOFF (hex 13, ctrl-S)</p>		<p>Turns off serial handshaking, Scale output enabled (available only when Parameter H5 = 5F)</p>
<p>ELx (hex 45, hex 4C)</p>	<p>* (acknowledgment)</p>	<p>Enter Label in buffer number x = 1 to 4 See Label Buffer Configuration</p>
<p>RLx (hex 52, hex 4C)</p>	<p>Label buffer string</p>	<p>Read Label in buffer number x = 1 to 4 See Label Buffer Configuration</p>
<p>D or d (hex 44, hex 64)</p>	<p>Print Buffer data</p>	<p>Dumps serial data that is stored in Print Buffer. Active when Serial Handshaking is set for 485 mode.</p>

<CR>	<p><p><xxx.xx><SP><uu><SP><mm><SP><SP> <CR> <LF><EOT> or <CR><ETX></p>	<p>“UPS” UPS Worldship format, Prints current weight, units, and motion status. <xxx.xx> weight data (fixed field of 5 digits plus decimal). <mm> motion status ("GR" = stable or "gr" = motion). <EOT> end of transmit (hex 04) <ETX> end of text (hex 03) Note: if scale is in error condition. Scale will respond with a <CR><ETX></p>
RSx (hex 52, hex 53)	Setpoint weight value.	<p>Read weight value in Setpoint number x = 1 to 8 See Remote Setpoint Entry and Recall.</p>
ESx (hex 45, hex 53)	<p>* (acknowledgment) Display will show an "5RUEd" to indication that the setpoint value has been successfully saved to non-volatile memory</p>	<p>Enter weight value in setpoint number x = 1 to 8 See Remote Setpoint Entry and Recall.</p>

Table 2: Doran serial protocol

Specifications and Interconnect Data

Specifications:

Model:	7400	4300	7000XL	8000XL
Resolution:	200d to 50,000d			
Sensitivity:	0.5 uV min.			
Load Cell Capacity:	0.283 mV/V to 5 mV/V			
Power Supply:	115 / 230VAC 50/60Hz			
6V Battery	Optional			Standard
Display:	6 digit LED. 0.56" high			
Displayed units:	lb, kg, oz, g and lb oz			
Capacities:	1 to 999,000 lb			
Printer Interface:	Bi-directional RS-232			
Calibration	Unit may be calibrated with 10%, 25%, 50%, or 100% of capacity Or user selected.			
Controls:	ZERO switches. Optional UNITS & PRINT switch.	Polycarbonate touch panel zero, units, print, hidden, over, under buttons	Polycarbonate touch panel zero, units, print, hidden buttons	
Construction:	Rugged Stainless Steel NEMA 4/4X (IP 65) construction.			
Options:	User configurable remote switch, 6 digit LED remote display, 4-20mA output, Ethernet (wired & wireless), Relay outputs, RS485			

Table 3: Scale Specifications

Interconnect Data:

PIN #	TITLE	WIRE COLOR CODE
1	+ Load Cell Signal	Red
2	- Load Cell Signal	White
3	+ Load Cell Excitation	Green
4	- Load Cell Excitation	Black
5	+ Sense Signal	Blue
6	- Sense Signal	Brown

Table 4: TB1 Load Cell Connections

NOTE: When connecting the loadcell, be sure to install the ESD and EMI protection inductor. Refer to Fig. 11 for details.

P2 Options Connections		
PIN #	TITLE	WIRE COLOR CODE
1	RXD	White
2	TXD	Red
3	Remote Switch High	White
4	Ground	Black
5	Ground	Black

Table 5: P2 Options Connections

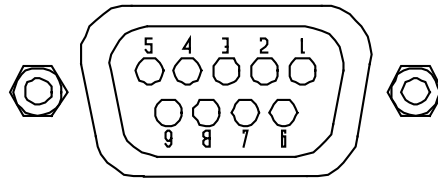

Fig. 10: RS232 Output DB9 Connector (optional)

RS232 Output DB9 Female connector (see Fig. 10)	
Function	Pin
N/A	1
TXD	2
RXD/CTS	3
N/A	4
Signal GND	5
N/A	6
N/A	7
N/A	8
N/A	9

Table 6: Serial Output pin description

P3 Keyboard Connections	
PIN #	TITLE
1	Ground
2	Zero Switch
3	Units / Under Switch
4	Print / Over Switch
5	Hidden Switch
6	Keyboard Scan

Table 7: P3 Keyboard Connections

J1 Power Connections		
PIN #	TITLE	WIRE COLOR CODE
N	Neutral	Blue or White
G	Ground	Green or Green/Yellow
L	Hot	Brown or Black

Table 8: J1 Power Connections

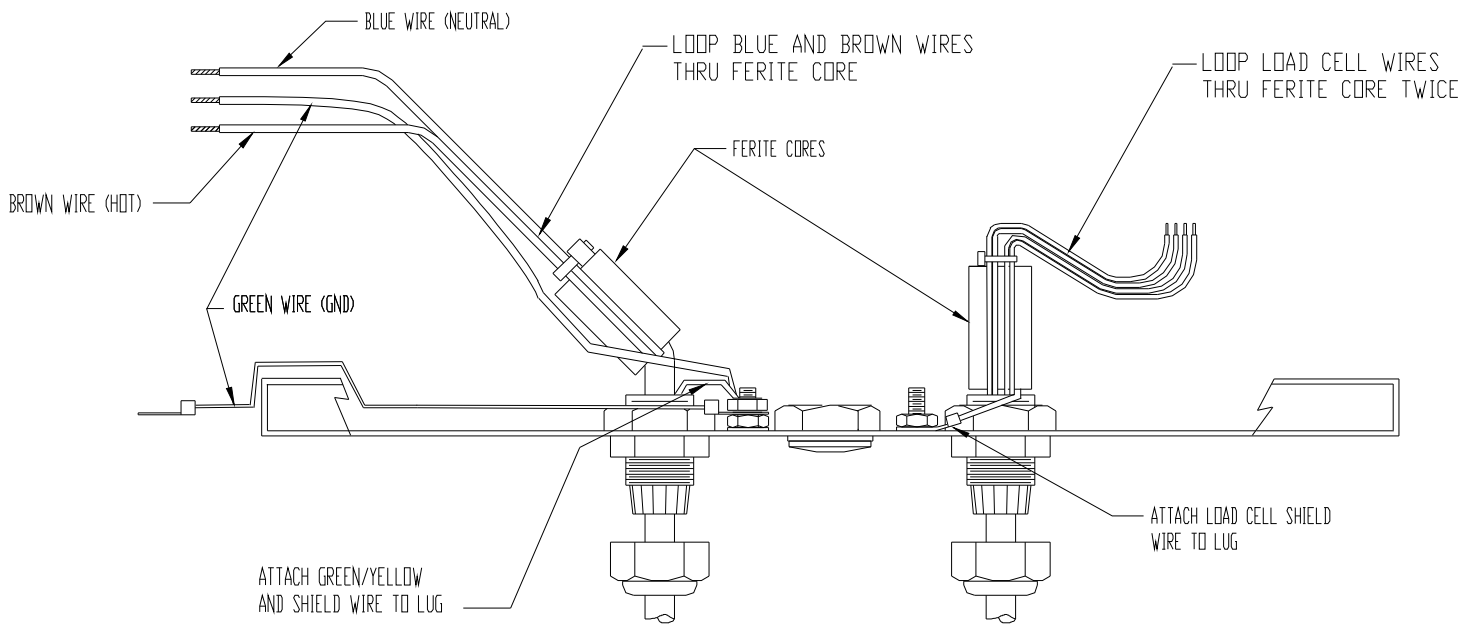

Fig. 11: Installation of EMI / RFI / ESD protection devices.

NOTE: Fig. 11 illustrates a scale connected with a 4-wire load cell. When installing a 6-wire cell, remove shunts at JU7 and JU8.

Fuse Replacement:

The Scale's line fuse (F1) is located next to the power terminal (J1). Make sure power is off, before replacing the fuse. Remove the fuse cap by unscrewing it counter clockwise, then pull the fuse out of the socket and insert the new fuse in socket (see FIG. 13). Then screw the fuse cap back on the socket and apply power to the scale.

Product (option)	Line Voltage	Part number	Description
7400, 4300, 7000XL	115 VAC	FUS0019	T250mA250V SLO-BLOW
7400, 4300, 7000XL	230 VAC	FUS0021	T125mA250V SLO-BLOW
7400, 4300, (battery)	115 VAC	FUS0020	T500mA250V SLO-BLOW
7400, 4300 (battery)	230 VAC	FUS0019	T250mA250V SLO-BLOW
7400, 4300 (Digital Output option)	115 VAC	FUS0020	T500mA250V SLO-BLOW
7400, 4300 (Digital Output option)	230 VAC	FUS0019	T250mA250V SLO-BLOW
8000XL	115 VAC	FUS0020	T500mA250V SLO-BLOW
8000XL	230 VAC	FUS0019	T250mA250V SLO-BLOW

Table 10: Line Fuse Values

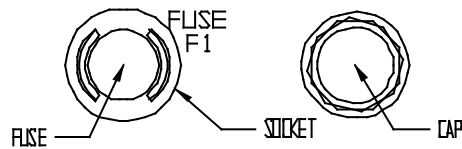

Fig. 13: F1 Fuse Holder

4-20mA Analog Output (optional)

Introduction

The 4-20mA Analog Output Option is used to provide an analog output that is proportional to the weight on the scale platform. Because of the inherent noise immunity present in a current loop, an isolated 4-20mA analog output is ideal for use in noisy environments. The 4-20mA analog output option can be used to send weight data to a process indicator, a simple on/off controller or to a programmable logic controller.

Setup

To setup the 4-20mA Analog Output Option, calibrate unit like a standard scale. This procedure is found in the instruction manual. The 4-20mA option is automatically calibrated for an output range of 4mA to 20mA, (i.e. 4mA equals zero weight and 20mA equals the scale's capacity). Once the basic scale has been connected and calibrated, attach the output cable from the appropriate controller or indicator to the 4-20mA option board. The white lead is connected to the + input of TB2 and the black lead is connected to the – input of TB2.

Active (default)(Fig 14.2) or Passive mode (Fig 14.3), if your application requires a self power (Active mode) analog output, place jumpers on pins 3,4 (ACT) on JU1 and JU2. For loop power (Passive mode) applications, place jumpers on pins 1,2 (PAS) on JU1 and JU2. See Fig 14.1 for jumper locations.

Calibrate your process indicator or controller according to the manufacturer's instructions. Remember that the option will output 4mA when the scale reads "zero" and 20mA when the scale reads full capacity. **NOTE:** If the scale is in a fault condition, the 4-20mA output levels are 3.5mA for gross underload or underload, and 24mA for gross overload or overload. Output impedance range is zero to 600 ohms.

Operation

There is no effect on scale operation when the 4-20mA Analog Output Option is installed. The only exception to this is on the 8000XL or model with battery option where battery life will be reduced by 50% when the 4-20mA option is set to the active mode. To increase battery life back to normal, set option output for passive mode.

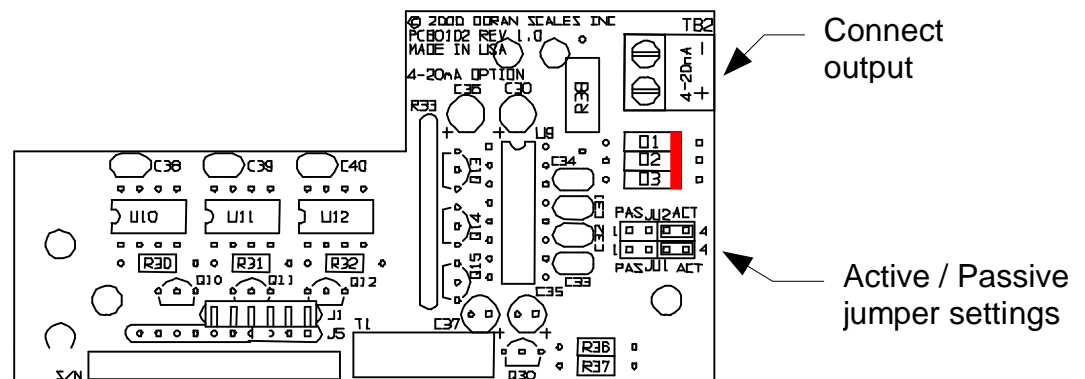

Fig. 14.1: 4-20mA Analog Option Board

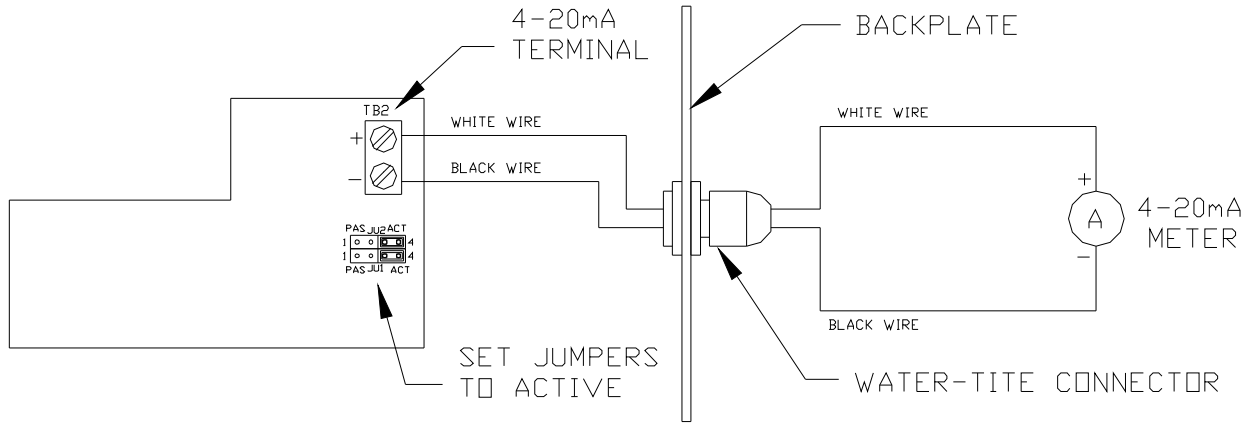

Fig. 14.2: Example of a Active 4-20mA circuit.

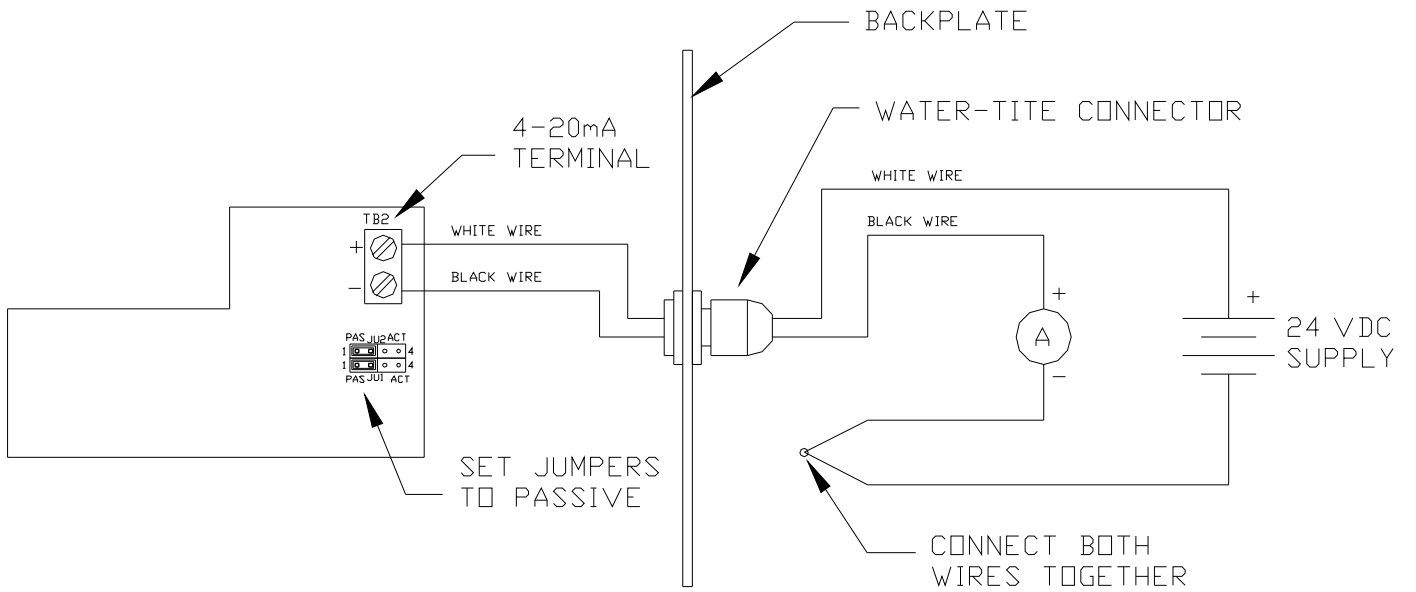
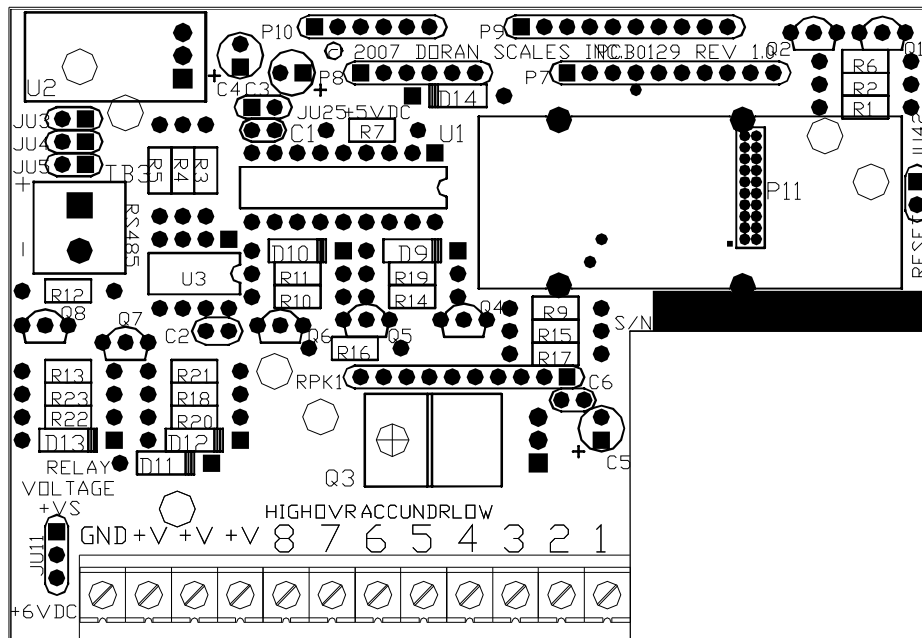

Fig. 14.3: Example of a Passive 4-20mA circuit.

Digital Output Board (optional)

The Digital Output Board can be factory configured into four different versions. All four versions do include a relay driver circuit that can control up to eight outputs. The standard base version EXOPT104 consists of only the relay driver circuit. The EXOPT101 has an additional Wired Ethernet Network Interface, refer to Wired Ethernet section for more details. The EXOPT102 has an additional Wireless Ethernet Network (802.11b) Interface, refer to Wireless Ethernet section for more details. The EXOPT105 has an additional RS485 Interface, refer to RS485 Communication section.



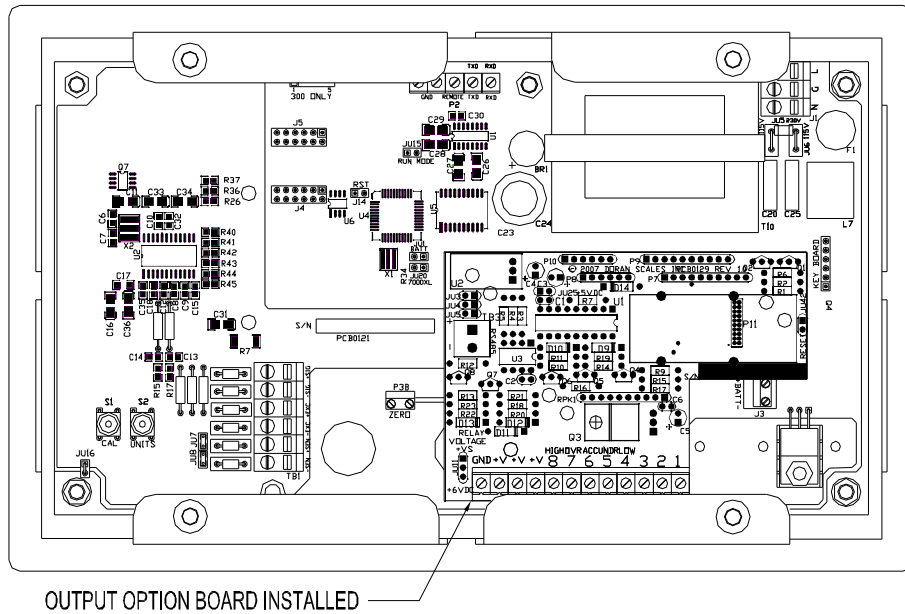

Fig. 15.2: Digital Output Board Installed

6 Volt settings (Default): When using the 6 volt mechanical relay (RLY0033). Add Jumper at JU11 between pins 2 and 3. No jumper at JU11 between pins 1 and 2. JU25 should have no jumper.

Unregulated 9-12 volt settings: Add Jumper at JU11 between pins 1 and 2. No jumper at JU11 between pins 2 and 3. JU25 should have no jumper.

5 Volt settings: When using the 5 volt mechanical relay (RLY0027). Add Jumper at JU25. Remove all other jumpers at JU11.

External Power Supply settings: When using an external supply, remove all jumpers from JU11 & JU25.

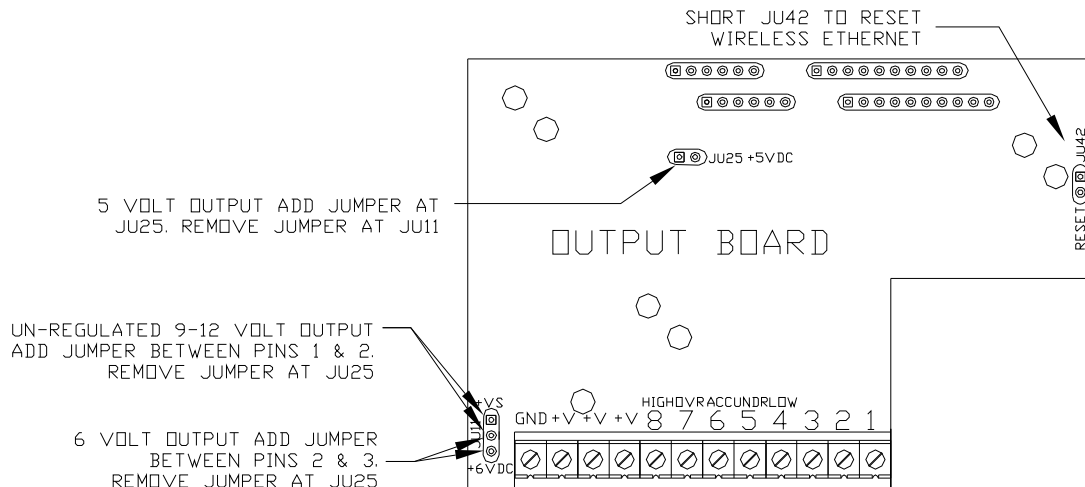

Fig. 15.3: Digital Output Board Jumper Locations

RS485 Communications (optional)

The scale offers an RS485 data communications option. RS485 communications are similar to RS232 except that RS485 provides better noise immunity, it is suited to longer cable distances, and it will allow multiple scales to be attached to the same data line.

RS485 achieves its performance advantage over RS232 by utilizing a differential input and output. In other words, the RS485 device sends two copies of its data; one in positive logic and in negative logic. The receiving device looks at the two outputs and takes the difference between them. If the difference is positive the bit is a "1" if it is negative, it is a "0."

The ability of RS485 to have multiple devices attached to the same line complicates the serial communication. Because of the multiple device capability, each device must have a unique dedicated address. Also, no device is permitted to communicate unless the master serial bus controller has specifically activated it. Since a scale with RS485 may not communicate unless it is activated by the master serial bus controller, a print buffer is provided to store scale data until it is requested.

When the indicator is setup RS485 communication, all print requests are redirected to the print buffer rather than the printer port. All weight readings are stored in this buffer until a buffer dump command is received from the serial port. Once the dump command is received, the scale takes control of the serial bus and transmits the stored scale readings. When the buffer is empty, the scale releases the bus and will not communicate until the master serial bus controller again activates it.

Warning: if scale data stored in Print Buffer exceeds buffer size, only the latest data that will fit in buffer, will be saved. If the scale is set for the default print string "F0", the buffer will store up to 15 print strings before overflowing the buffer size.

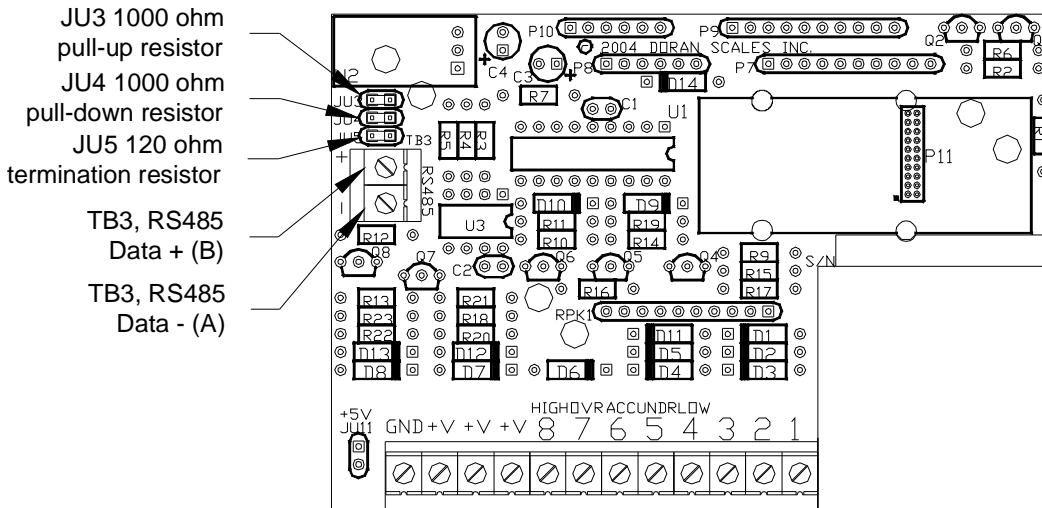

Fig. 16.1: Digital Output Board with RS485 Option

RS485 SETUP

The following section assumes that you are familiar with the operation of the parameter setup menu. If you are unsure of any step while setting up RS485 operations, please read previous sections in this Instruction Manual before continuing.

Setting up RS485 communications in the system requires that the scale be connected to the RS485 bus. Using a two-wire data cable attached to TB3 on the Digital Output option board makes this connection. See Fig. 16.1 and Fig. 16.2 for details on the necessary connections. You will need to know and understand the operation of other RS485 devices in your system.

After setting up the cable, the scale must be configured to work with the RS485 bus. Enter the setup mode and scroll through the setup menu until you come to the Serial Data Output Handshaking and set it for RS485 mode. Next, press "UNITS" to step to Scale (Bus) Address parameter. The scale will ship from the factory set for address "00". Press "ZERO" to scroll up the value for bus address. Be sure to record the address you selected. At this time, the RS485 buffer is activated.

Note: If the Data Output Handshaking is not set to RS485, the scale will behave as if the scale is communicating via RS232. This may be desired for a RS485 bus with one scale on the bus or an application where communication with a single scale over a long distance is required.

Once the scale address is set, select the "Data Output Mode." Doran Scales recommends against using the Continuous Print Mode with RS485 because the buffer will fill up quickly requiring frequent readings of the buffer. If you require an automatic recording of weight data, then the Auto Print mode AP2 is recommended.

RS485 Option Specification	
Maximum Cable length	4,000 ft.
Maximum number of scales per bus	32 nodes
Maximum Number of Print commands that can be stored in Print Buffer (256 bytes)	15 with Print Output format = "F ⁿ "
Bus common mode range	±7 volts
RS485 node load impedance	12K ohms

Table 11: RS485 Option Specification

RS485 Commands

In order to communicate with your scale, your bus controller must send the scale commands in a format it expects. The scale's communications string is constructed as follows:

01 <SC> <CR>

Where; "01" is the scale bus address (01 to 99)
 <SC> are the scale commands.
 <CR> Carriage Return is a ASCII character (0x0d hex or ^M)

Example: "01W␣" Initiates a print command that will store data to the Print Buffer at address 01.

It is possible to broadcast a command to all scales on the RS485 bus by using scale bus address "00". All scales will receive this command and will respond. **Warning:** Do not use this command to dump the contents of the scale buffer as all the scales on the bus will attempt to communicate at once and will result in the loss of data.

All scale commands as laid out in the Data Communications section, Table 2 are available for use in RS485 communications. The following are some common commands recognized by the scale:

- W Instructs the scale to print to the print buffer.
- Z Instructs the scale to perform a "ZERO" operation.
- D Instructs the scale to dump (or transmit) the Print Buffer's contents to the bus. The Print Buffer is then cleared of all data.

Bus termination resistors

Since RS485 systems are designed to cover long distances, it is often necessary to terminate the bus at its ends. This termination reduces reflections on the bus and provides a pull up for the bus drivers. The RS485 option board has these termination resistors built in and jumper accessible. Table 12 provides terminator resistor jumper information.

Jumper settings for RS485 line	
Function	Jumper
120 ohm line to line Termination Resistor	JU5
1K ohm pull up Bias Resistor	JU3
1K pull down Bias Resistor	JU4

Table 12: RS485 Termination Resistors

In general, JU5 should be inserted at the terminating ends of a long RS-485 bus. Scales (nodes) located between these ends do not need this resistor. JU3 and JU4 are used to provide bias to the bus and at least one pair of pull up / pull down resistors are required somewhere on the bus. Additional sets are probably not required, but every installation will require some judgment by the installer.

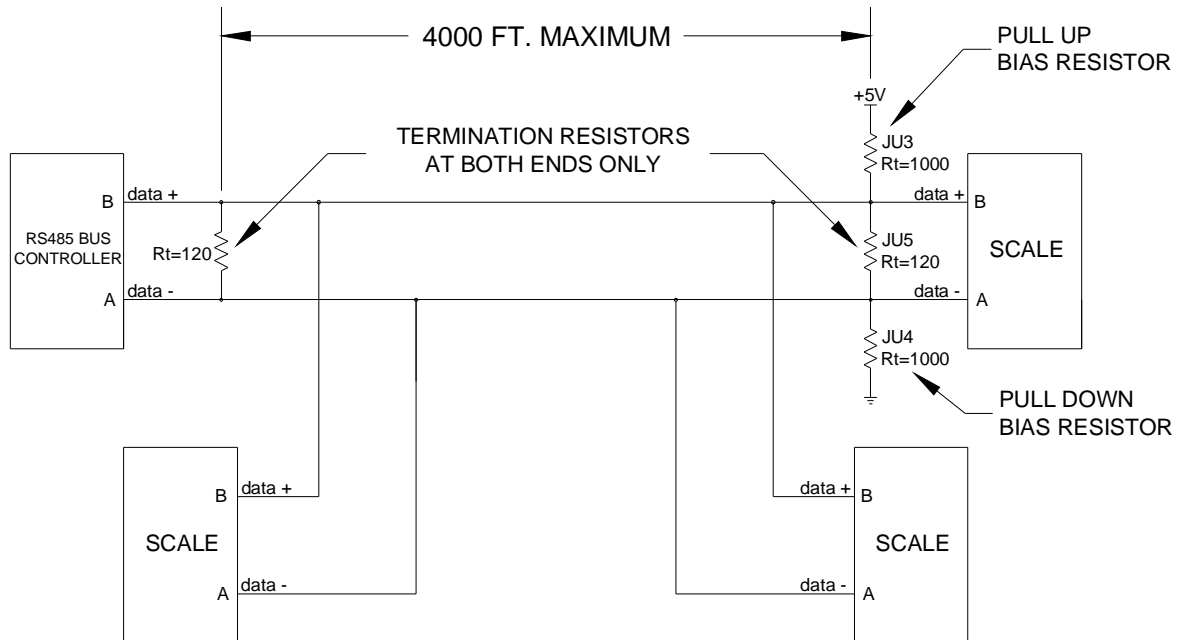

Fig. 16.2: RS485 two wire system

Internal Relay Option (optional)

The Internal Relay Option (EXOPT106) allows up to four relays to be mounted inside the scale's enclosure. The relay control is described in Parameter Setup Section. This section discusses the installation and wiring of the relay controls.

Three types of relays are available for use with the Internal Relay Option – Electromechanical and Solid State (AC or DC). Specify style of relay at time of order. Relays are socked so replacements can be installed in the field.

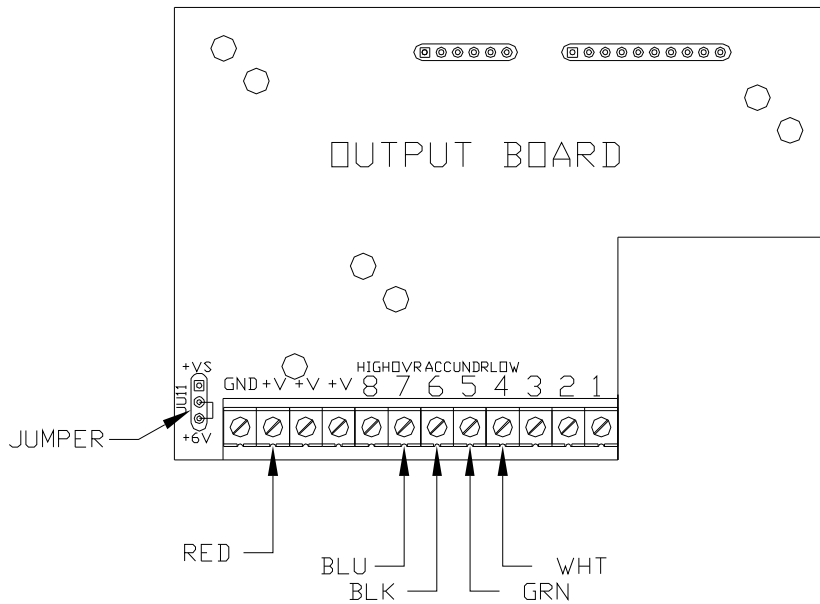

Fig. 17: Digital Output Board Wiring

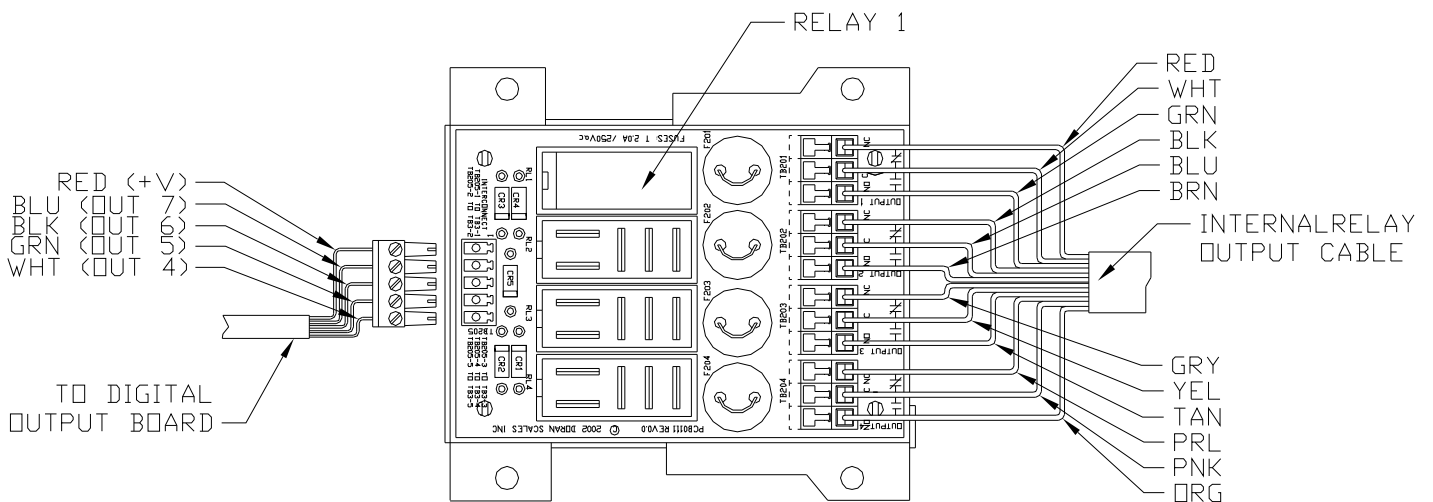

Fig. 18: Internal Relay Board

Internal Relay Setup:

The internal relay option comes with an interface cable between the Digital Output board and the internal relay board for relay control. A second twelve conductor cable provides the relay output and exits the meter through a watertight. Leave this cable in place when configuring the outputs and refer to the output cable color code table. In the field, this cable will most likely be replaced. Ensure that the replacement cable is rated well above the maximum current required by the electrical device to ensure safe operation and the cable diameter is between 0.16” and 0.31” for proper watertight sealing. The Scale does not provide the AC or DC power to run external devices. Ensure your customer has made provisions to supply the necessary power.

Each relay has a three-position output that provides a Common, Normally Open and Normally Closed terminal. Keep in mind that the Normally Closed terminal is only available for use with a mechanical relay. Solid State relays can operate as Normally Closed through software configuration only. The following table shows the color codes and terminal connections for the included cable.

Relay Specifications:

Mechanical Relay, 10A 250VAC / 30VDC. Doran part number: EXOPT108

AC Solid State Relay, 2A 100-240VAC. Doran part number: EXOPT109

DC Solid State Relay, 2A 5-48VDC. Doran part number: EXOPT110

Channel	Terminal	Conductor Color
Relay 1 (UNDER)	TB201 – NC	Red
	TB201 – COM	White
	TB201 – NO	Green
Relay 2 (ACCEPT)	TB202 – NC	Black
	TB202 – COM	Blue
	TB202 – NO	Brown
Relay 3 (OVER)	TB203 – NC	Grey
	TB203 – COM	Yellow
	TB203 – NO	Tan
Relay 4 (HIGH)	TB204 – NC	Purple (Pearl)
	TB204 – COM	Pink
	TB204 – NO	Orange

Table 13: Internal Relay Output Cable Color Code

Step-up Relay Circuit:

If the current load to be switched is greater than the maximum current limit of the internal relay, i.e. 10 Amps for mechanical relay or 2 Amps for Solid State Relay. A step-up relay circuit is required in order to switch the higher current loads. See Fig. 19 for an example of a typical step-up relay circuit.

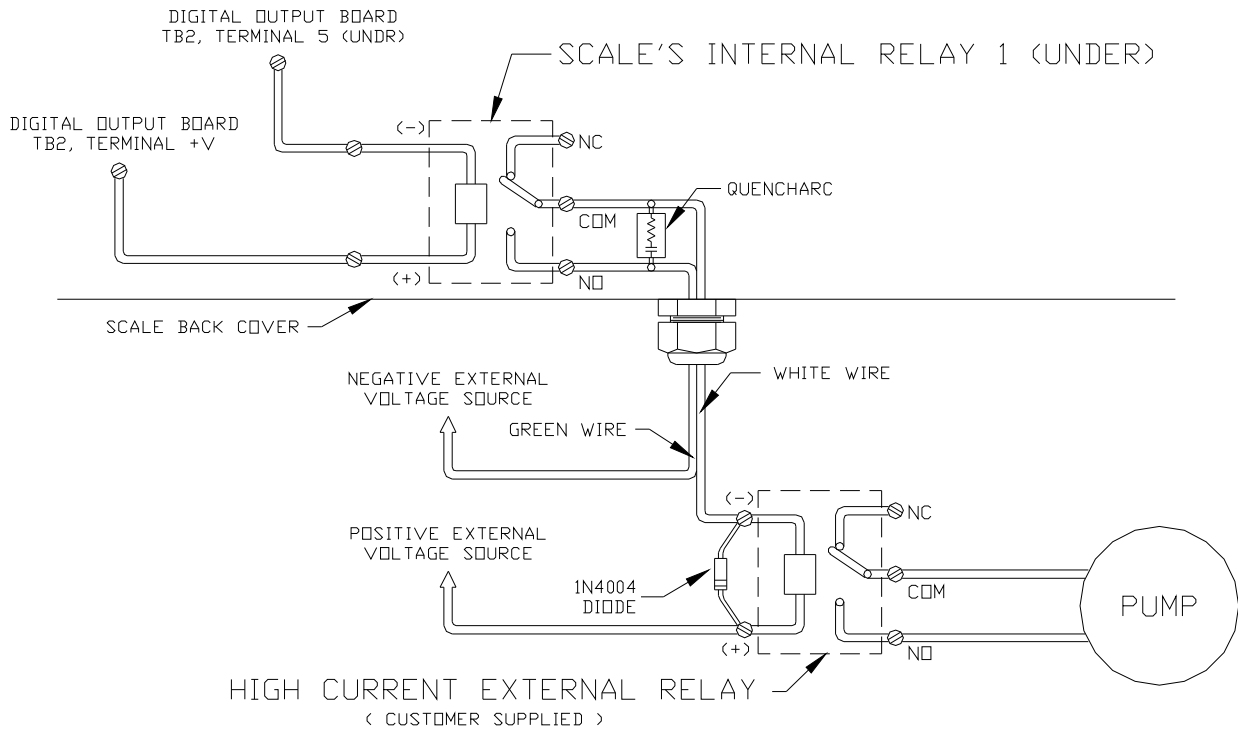

Fig. 19: Example of a Step-up Relay circuit.

External Relay Box Option (optional)

The External Relay Box Option (EXOPT107) consist of a +6V Power Supply and up to eight DIN rail mounted relay modules, see Fig 20. The Relay Box is a NEMA4X polystyrene enclosure (10" W x 7" H x 6" D) with a clear cover. The housing has knock-out plugs with sizes of 7/8", 1-1/8", 1-1/2" located on all four sides, see Fig 20. Three types of relays are available for use with the External Relay Box Option – Electromechanical and Solid State (AC or DC). Specify style of relay at time of order. Relays modules are mounted on a DIN rail, so replacements or additional channels can be installed in the field.

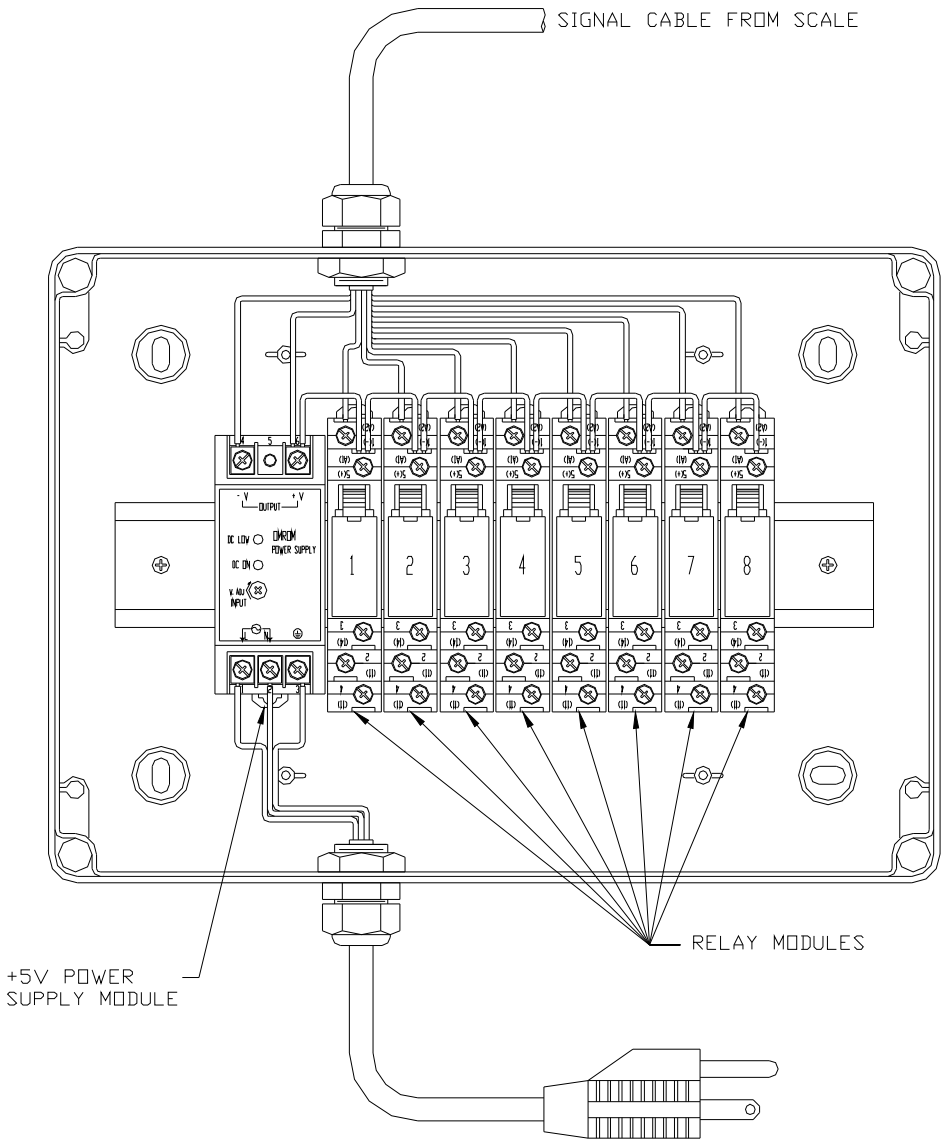

Fig. 20: External Relay Box

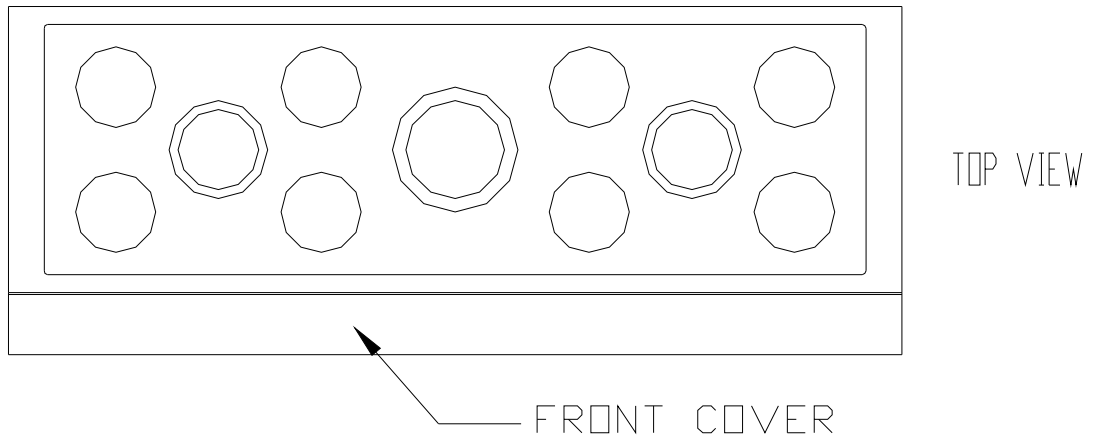

Fig. 21: Knock-out Plugs

External Relay Setup:

The Relay module is offer with three different types of relays, mechanical and solid state (AC or DC). The mechanical relay's output consists of terminal 4 - common (COM), terminal 3 - normally open (NO), and terminal 2 - normally closed (NC) (see FIG 22). The mechanical relay (OMRON G2R-1-SN) is rate for a maximum of 10A @250VAC or 10A @30VDC. Relay drive current for mechanical relay is 70mA @ 6VDC. The solid state relay's output consists of terminal 3 and 4 - normally open (NO). The solid state relay (OMRON G3R-OA202-SZN / G3R-ODX02SN-DC524) is rated for a maximum of 2A @100-240VAC / 2A @5-48VDC. Relay drive current for solid state relay is 11mA @ 6VDC. The relay control is described in Parameter Setup Section. Table 14 lists the scale signal cable wire color control for each relay module.

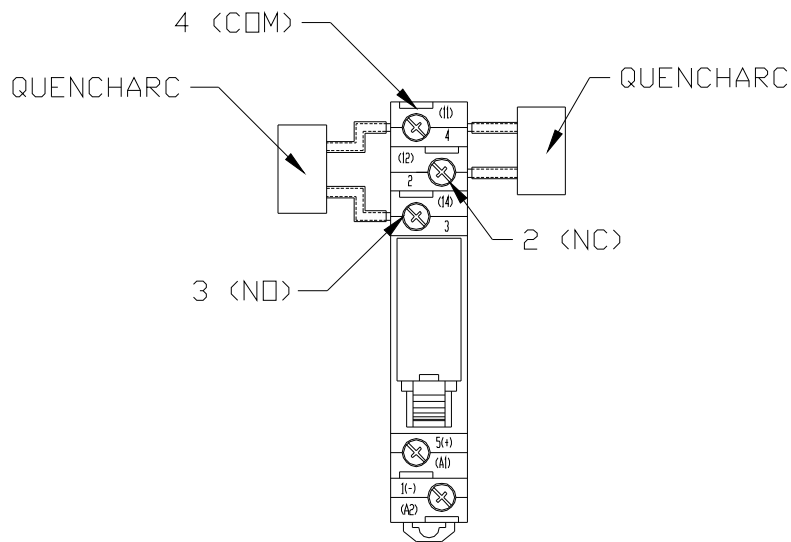

Fig. 22: Mechanical Relay Module

Module	Terminal	Conductor Color
Relay 1	1(-) A2	Brown
Relay 2	1(-) A2	Red
Relay 3	1(-) A2	Orange
Relay 4	1(-) A2	Yellow
Relay 5	1(-) A2	Green
Relay 6	1(-) A2	Blue
Relay 7	1(-) A2	Purple
Relay 8	1(-) A2	Grey
Power Supply	Output +V	White
Power Supply	Output -V	Black

Table 14: Scale Signal Cable Color Code

Digital Output Board Setup:

Digital Output board requires the jumper at JU11 to be cut in order to be used with the External Relay Box option. Wiring connections for the signal cable to the Digital Output board are shown in Fig 23 below.

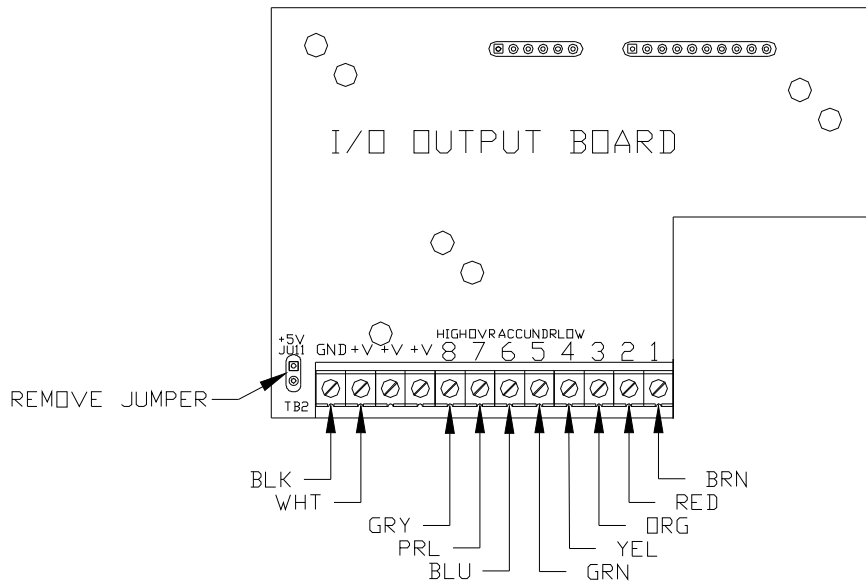

Fig. 23: Digital Output Board Wire and Jumper locations.

Note: Jumper at JU11 and JU25 should be removed when using an external power supply, see Fig 23.

Wired Ethernet Option (optional)

The Wired Ethernet Option (EXOPT101) connects your Excel Series scale to an Ethernet network. The Digital Output board equipped, with the Ethernet module, installs inside the washdown safe enclosure. The NEMA4X sealed RJ-45 Ethernet connector is bulkhead mounted to the rear panel of the indicator (See Fig 24).

The Wired Ethernet Option auto senses 10/100Base-T networks, so network configuration is simple. The Wired Ethernet Option is fully compliant with the 10/100Base-T Ethernet network standard, transferring data up to 100Mbps. Once the scale is connected you can collect data, remotely configure, or monitor the scale from any computer on the network.

Features and Applications:

- E-mail alerts are user definable based upon scale's setpoint status or fault event.
- Remotely configure your scale parameters.
- Collect and analyze scale process data.
- Monitor the scale status in real time.
- Remotely control a the scale in real time.

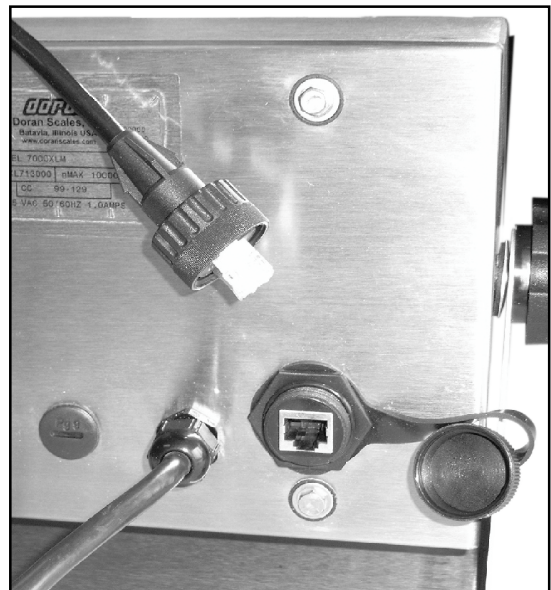

Fig. 24: RJ-45 Ethernet connector

Specifications:

Hardware: Bulkhead mount NEMA4X sealed RJ-45 connector

Network Interface: 10/100Base-T Ethernet protocol, Data rates up to 100Mbps
Universal IP address assignment
Static IP
DHCP
Operating Temp. 14° F to 104° F

Regulatory Approvals: FCC Part 15 Class B, FCC Part 15 Subpart C Sec. 15.247

Options: Washdown Safe RJ-45 Ethernet Connector Field Install Kit (EXOPT150)

Doran Wired Ethernet Configuration Guide

The Doran Wired Ethernet option comes with a NEMA 4X washdown safe bulkhead mount connector on the rear of the scale. The mating field installable connector is available from Doran (P/N EXOPT150) and can be installed on customer supplied cabling.

You have two options for Wired Ethernet, Static IP or a Dynamic IP address. Dynamic IP works with a DHCP server and is the default configuration. Each time the scale powers up, the network will assign a new IP address to the scale. If Dynamic IP is desired, simply connect the scale to your network switch and skip to step 6 of the following instructions.

Static IP addresses use the same IP address each time the scale connects to the network. No two devices can share the same IP address. For the Static IP address to always be available on the network, the server must be configured to reserve the Static IP address. To configure a Static IP address, follow the instructions below.

1. Run the *dgdiscvr.exe* software provided with the Doran Scale on a PC connected to the network and on the same subnet. When this program is executed, all Doran Wired and Wireless Ethernet devices connected to your network will be listed.

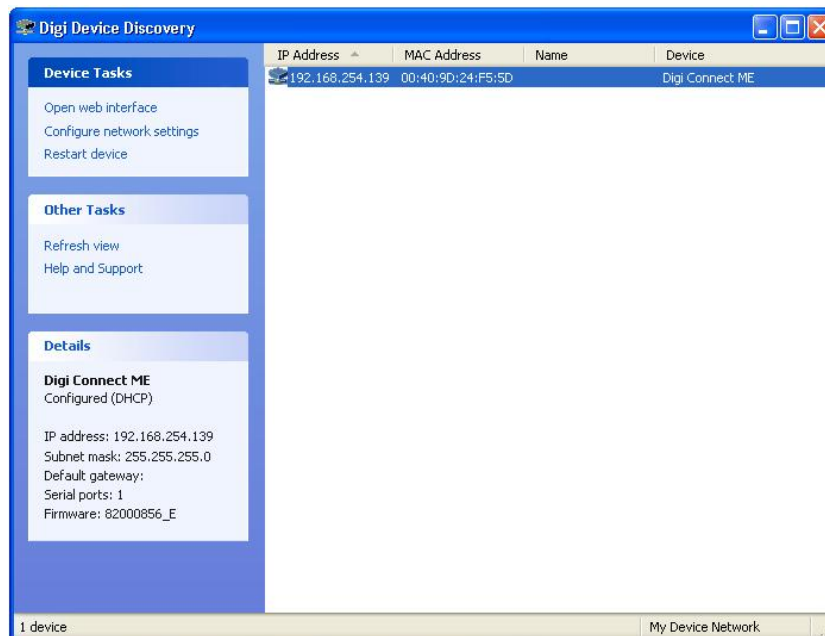

2. Highlight the device you want to configure and click on Open web interface. If you have multiple devices that are new to the network that need to be configured, the scale can be identified by the MAC address. The MAC address can be found just above the Ethernet connector on the rear of the scale.

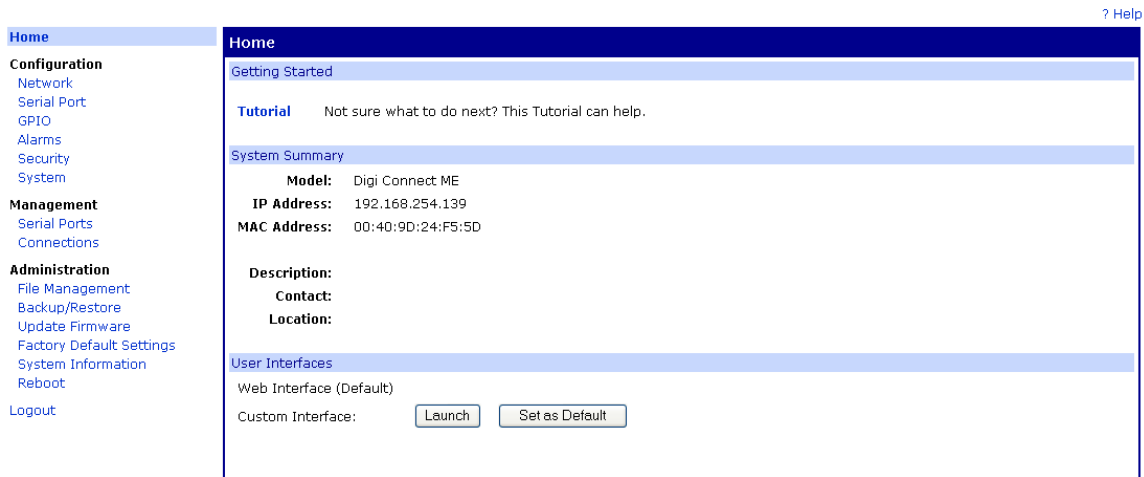

3. If you wish to have a Static IP address, click on Network under the Configuration header on the left.

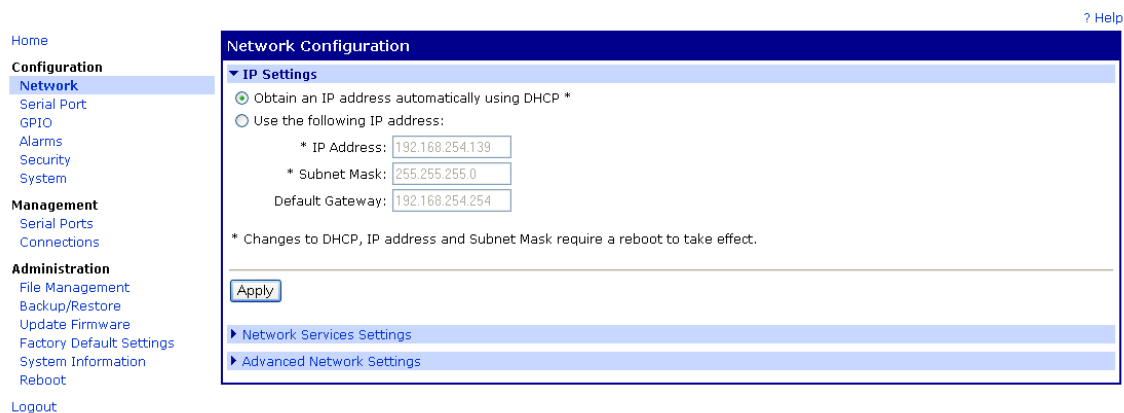

4. To configure to a Static IP address, click on Use the following IP address radio button and fill in the required network IP address fields. The IP Address field contains the current IP address assigned by the DHCP server. This IP address can remain the same if desired. When configuring the static IP address, be sure that no other device on your network is actively using this IP address. Be sure to reserve this Static IP address in the DHCP server to ensure another device will not be assigned this IP address. Once the IP address is confirmed and available on your network, click Apply to accept the changes.
5. To implement the changes, click on Reboot to reset the Wired Ethernet option. The webpage will briefly display Reboot In Progress. Once the reboot is complete, the web page will return to the device configuration home page. The web browser can now be closed.

6. Return to the Digi Device Discovery program from step 1 and click on Refresh View. Check to see if the newly configured device does appear on the list of connected devices with the proper IP settings. Highlight the Ethernet device by clicking on it and the device settings will be shown in the Details window on the left of the program window. The device will show that it is configured and the IP address status will be shown to be DHCP or Static. Be sure that the device does not have a red explanation mark next to it in the main window. A red explanation mark indicates the device can be configured, but does not have the correct IP address required to communicate with your pc for data collection and scale configuration purposes. If necessary, reconfigure the scale with the proper IP Address, Subnet Mask and Default Gateway. If the network connection icon is displayed as shown in the Digi Device Discovery screen shot above, you can communicate with the scale from your PC.

Module LED Description

The Wired Ethernet module has two types of LEDs.

Amber (Yellow) LED, located top left on module indicates Network link status. Blinking - Unit is trying to connect to a network.. Off - no connection to network. On - a link has been established.

Green LED, located top right on module indicates Serial port or Network activity. Off - the serial channel is idle. Blinking - serial data is transmitted or received.

Wireless 802.11b Ethernet Option (optional)

The Wireless Ethernet Option (EXOPT102) connects your Excel Series scale to an wireless network. The Digital Output board equipped, with the Wireless Ethernet module, installs inside the washdown safe enclosure. The antenna is bulkhead mounted to the rear panel of the indicator and sealed for harsh environments as well, see Fig 25.

The Wireless Ethernet Option lets you put your scale almost anywhere in the building, without the cost and hassle of running cables. Once the scale is connected, you can collect data, remotely configure, or monitor the scale from any computer on the network.

The Wireless Ethernet Option is fully compliant with the 802.11b wireless network standard, transferring data at up to 11Mbps in the 2.4GHz radio band. Wireless communications is protected by up to a 128-bit security encryption.

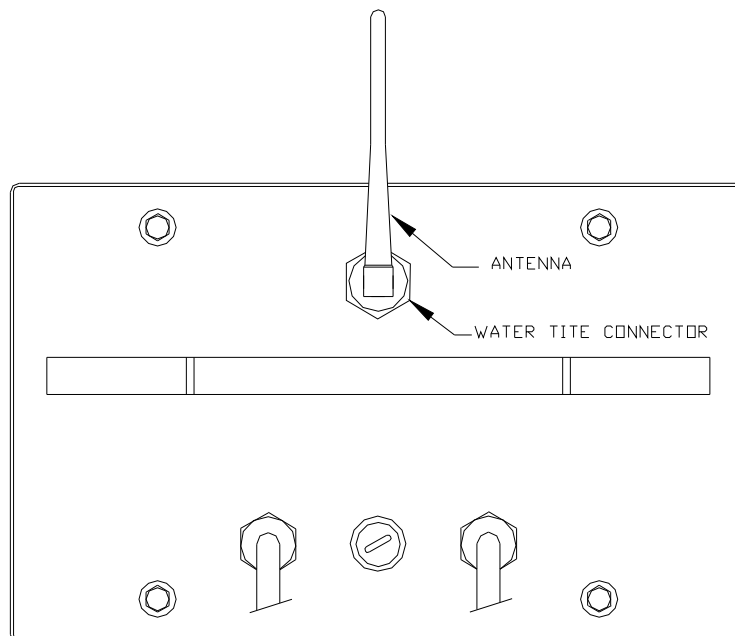

Fig. 25: Wireless Ethernet Antenna

Features and Applications

- E-mail alerts are user definable based upon scale's setpoint status or fault event.
- Remotely configure your scale parameters.
- Collect and analyze scale process data.
- Monitor the scale status in real time.
- Remotely control the scale in real time.
- No communication cables to connect.

Specifications:

Hardware: Bulkhead mount 2.4 GHz Dipole Antenna

Network Interface: 802.11b Ethernet Protocol
Data rates up to 11Mbps
Universal IP address assignment
Static IP
DHCP
2.4 GHz Frequency
16 dBm Transmitting Power
Receiving Sensitivity
-82 dBm at 11 Mbps
-92 dBm at 1 Mbps
Operating Temp. 14° F to 104° F

Wireless Security: WPA (Wireless Protected Access)
128-bit TKIP Encryption
802.1x EAP Authentication
WEP (Wired Equivalent Privacy)
64/128-bit RCA Encryption

Regulatory Approval: FCC Part 15 Class B
FCC Part 15 Subpart C Sec. 15.247

Doran Wireless Ethernet Configuration Guide

To connect your Doran Wireless Ethernet option to your network, the Wireless Ethernet option will need to be configured to communicate with your Wireless Access Point (WAP). The WAP must be connected to your network and functioning properly. You will need a PC connected to the network – preferably through wired Ethernet, not through the WAP you are reconfiguring. Communications to devices and PCs connected to the WAP you are reconfiguring may lose communication when certain WAP parameters are reconfigured. Refer to the WAP supplied documentation to change WAP parameters.

1. Configure the customer supplied Wireless Access Point to broadcast the SSID.
2. Disable any WEP or WPA security in your WAP.
3. Turn on the Doran Scale with the Wireless Ethernet option installed. Be sure to have the scale near the WAP to prevent any interference with communication while configuring the Wireless Ethernet option. Wait 30 seconds after the scale is powered up to allow the Wireless Ethernet option to begin communications. The Wireless Ethernet option will connect to any WAP broadcasting an SSID without security enabled.
4. Run the *dgdiscvr.exe* software provided with the Doran Scale on a PC connected to the network. When this program is executed, all Doran Wired and Wireless Ethernet devices connected to your network will be listed.

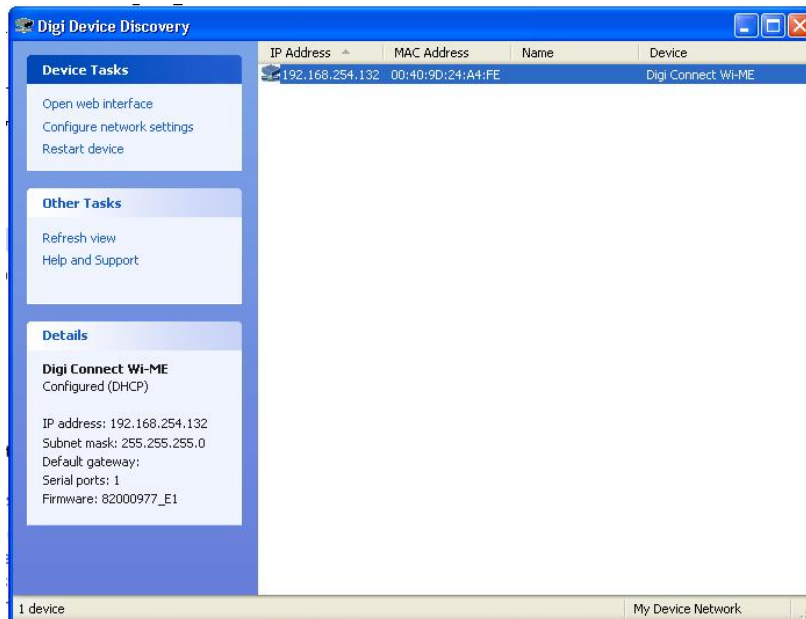

5. Highlight the device to be modified and click on Open web interface. If you have multiple devices that are new to the network that need to be configured, the scale can be identified by the MAC address. The MAC address can be found just above the antenna on the rear of the scale.

- A web browser will be launched that will allow you to reconfigure the selected device as seen below.

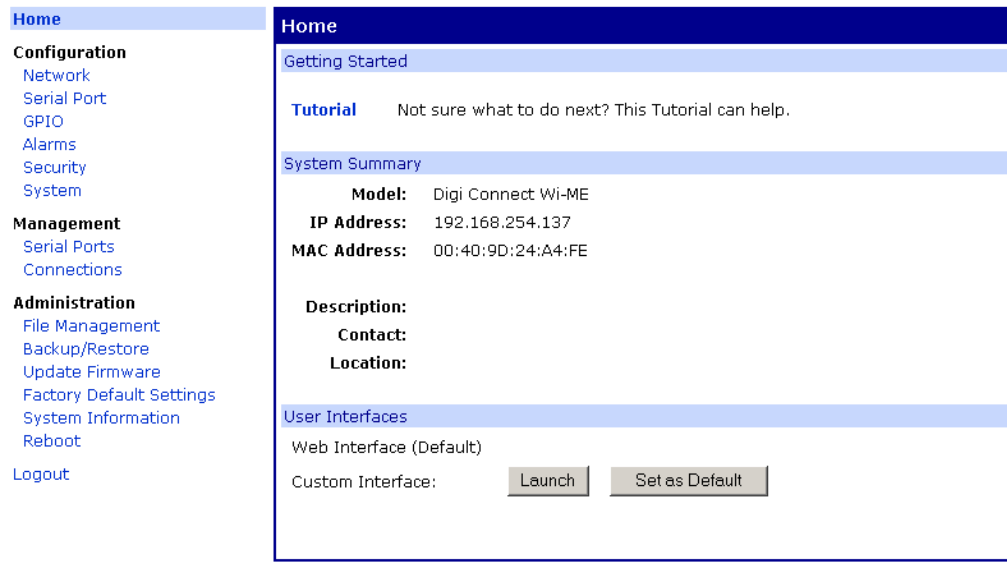

- Click on Network under the Configuration header on the left.

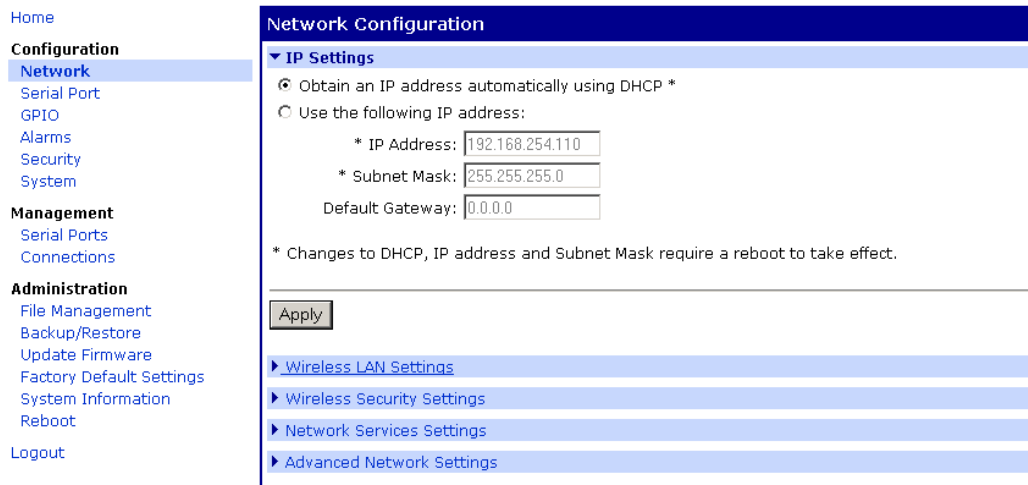

- To configure to a Static IP address, click on Use the following IP address radio button and fill in the required network IP address fields. The IP Address field contains the current IP address assigned by the DHCP server. This IP address can remain the same if desired. When configuring the static IP address, be sure that no other device on your network is actively using this IP address. Be sure to reserve this Static IP address in the DHCP server to ensure another device will not be assigned this IP address. Once the IP address is confirmed and available on your network, click Apply to accept the changes.
- To implement the changes, click on Reboot to reset the Wireless Ethernet option. The webpage will briefly display Reboot In Progress. Once the reboot is complete, the web page will return to the device configuration home page. The web browser can now be closed.

10. Click on Network under the Configuration header on the left. Click on Wireless LAN settings to configure security settings.

The screenshot shows the 'Network Configuration' page. On the left is a navigation menu with categories: Configuration (Home, Network, Serial Port, GPIO, Alarms, Security, System), Management (Serial Ports, Connections), and Administration (File Management, Backup/Restore, Update Firmware, Factory Default Settings, System Information, Reboot). The main content area is titled 'Network Configuration' and has several expandable sections: IP Settings, Wireless LAN Settings (expanded), Wireless Security Settings, Network Services Settings, and Advanced Network Settings. Under 'Wireless LAN Settings', there are radio buttons for: 'Connect to wireless access points (infrastructure)', 'Connect to other wireless systems using peer-to-peer (ad-hoc)', 'Connect to any available wireless network', and 'Connect to the following wireless network'. The 'Connect to the following wireless network' option is selected. Below it is a text input field for 'Network name' followed by '(SSID)'. There are also dropdown menus for 'Country' (set to 'United States') and 'Channel' (set to 'Auto-Scan'). An 'Apply' button is located below these fields.

11. Select Connect to the following wireless network and enter the SSID (case sensitive) that the WAP is currently broadcasting and click Apply to save the changes.

12. If you are using WEP or WPA security on your WAP, click on Wireless Security Settings.

The screenshot shows the 'Network Configuration' page with the 'Wireless Security Settings' section expanded. It contains three main options, each with a checkbox: 'Enable WEP security' (checked), 'Enable WPA pre-shared key (WPA-PSK) security' (unchecked), and 'Enable WPA authentication' (unchecked). Under 'Enable WEP security', there is a 'Transmit key' section with radio buttons for keys 1, 2, 3, and 4. Below this are four 'Encryption Keys' input fields, with the first one containing ten asterisks. Under 'Enable WPA pre-shared key (WPA-PSK) security', there are 'Passphrase' and 'Confirm' input fields. Under 'Enable WPA authentication', there are 'Username', 'Password', and 'Confirm' input fields. An 'Apply' button is at the bottom of the section.

13. Click on the check box to enable any one of the available security settings. The WEP encryption key entry allows for 64 bit encryption (10 hex digits) or 128 bit encryption (26 hex digits). Use the encryption key or sign on that the WPA device will use. Once changes are made, click Apply to save the changes.

WARNING: Make sure to write down and save the security settings for the Doran Wireless Ethernet option to be sure to be able to access the Wireless Ethernet option once the SSID and security settings are changed. If required, the Wireless Ethernet Option can be reset to factory defaults – see Defaulting Wired an Wireless Ethernet Module below.

14. The changes in security and SSID setting do not take effect until you click on Reboot under the Administration header on the left. Click on Reboot to confirm that a reboot is desired. At this point, you will have to reconfigure your WAP to the security settings to allow the Doran Wireless Ethernet option to communicate with the WAP. You may have to reboot your WAP after the changes are made. If the same SSID and security settings are not implemented, communication will fail.
15. Return to the Digi Device Discovery program from step 4 and click on Refresh View. Check to see if the newly configured device does appear on the list of connected devices with the proper IP settings. Highlight the Ethernet device by clicking on it and the device settings will be shown in the Details window on the left of the program window. The device will show that it is configured and the IP address status will be shown to be DHCP or Static. Be sure that the device does not have a red explanation mark next to it in the main window. A red explanation mark indicates the device can be configured, but does not have the correct IP address required to communicate with your pc for data collection and scale configuration purposes. If necessary, reconfigure the scale with the proper IP Address, Subnet Mask and Default Gateway. If the network connection icon is displayed as shown in the Digi Device Discovery screen shot above, you can communicate with the scale from your PC.

Module LED Description

The Wireless Ethernet module has two types of LEDs.

Amber (Yellow) LED, located top left on module indicates Network link status. On - unit is associated with an access point. Blinking slowly - unit is in ad hoc mode. Blinking quickly - unit is scanning for a network. Blinking 1-5-1 sequence, confirms that the module has been defaulted to factory settings.

Green LED, located top right on module indicates Serial port or Network activity. Off - the serial channel is idle. Blinking - serial data is transmitted or received.

Doran Wireless 802.11b Ethernet Option Factory Configuration Data Sheet

Please fill out this form to provide the customer's wireless access point configuration. Filling out this form will enable Doran to configure your Wireless Ethernet Option at our factory. Configuration at Doran will save you time and effort configuring the Wireless Ethernet Option when it arrives at your facility.

Please note that the Wireless Access Point may need to be configured to communicate with 802.11b devices. Not all Wireless Access Points will support all of the following configurations. Please print clearly when filling out this form.

IP Address Configuration (check one only)

Dynamic IP Address (typical)

Static IP Address

Static IP Address

Static IP address

_____ . _____ . _____ . _____

Subnet Mask

_____ . _____ . _____ . _____

SSID

The SSID is case sensitive and is less than 32 characters in length.

Encryption Configuration (check one only)

WEP 64 bit

WEP 128 bit

WPA PSK

WPA Authentication

WEP Encryption Key Fields

WEP 64 bit encryption consists of 10 hex digits and 128 bit encryption consists of 26 hex digits.

WPA – Pre-Shared Key

The passphrase is 8 to 63 characters long.

WPA – Authentication

User Name: _____

Password: _____

**Doran Ethernet Option
Factory Configuration Data Sheet**

IP Address Configuration (check one only)

Dynamic IP Address (typical)

Static IP Address

Dynamic IP Address

No further information is required. The server will automatically provide a new IP address each time the scale powers up. This is the typical configuration and is recommended for most applications. Each scale is identified on your network through a unique MAC address.

Static IP Address

Static IP address

_____ . _____ . _____ . _____

Subnet Mask

_____ . _____ . _____ . _____

Defaulting Wired and Wireless Ethernet Modules

The wireless and wired Ethernet modules can be reset to factory defaults by shorting the two-pin header with the supplied jumper at JU42, located next to module while the unit is powered up. Once the amber (wireless) or green (wired) LED begins blinking a 1-5-1 pattern, remove the jumper. The module is now successfully defaulted. After about one minute the module will attempt to make a connection to a WAP without any security enabled. Once defaulted, the module needs to be configured for proper network communications.

1. Run the *dgdiscvr.exe* software provided with the Doran Scale on a PC connected to the network. When this program is executed, all Doran Wired and Wireless Ethernet devices connected to your network will be listed.

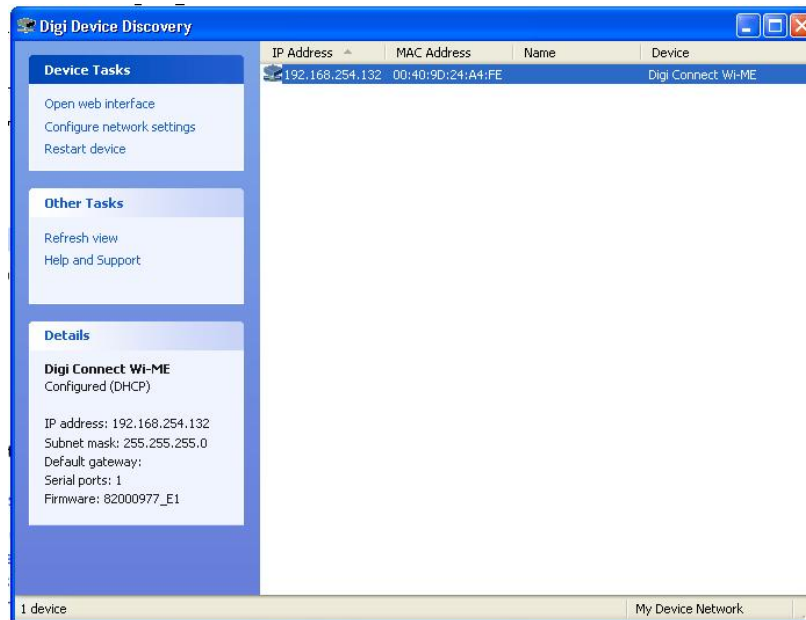

2. Highlight the device to be modified and click on Open web interface. If you have multiple devices that are new to the network that need to be configured, the scale can be identified by the MAC address. The MAC address can be found just above the antenna on the rear of the scale.
3. A web browser will be launched that will allow you to reconfigure the selected device as seen below.

4. Click on GPIO under the Configuration header on the left

5. Reconfigure Pin 1 through Pin 5 to In and click apply.

6. Click on Serial Port under the Configuration header on the left.

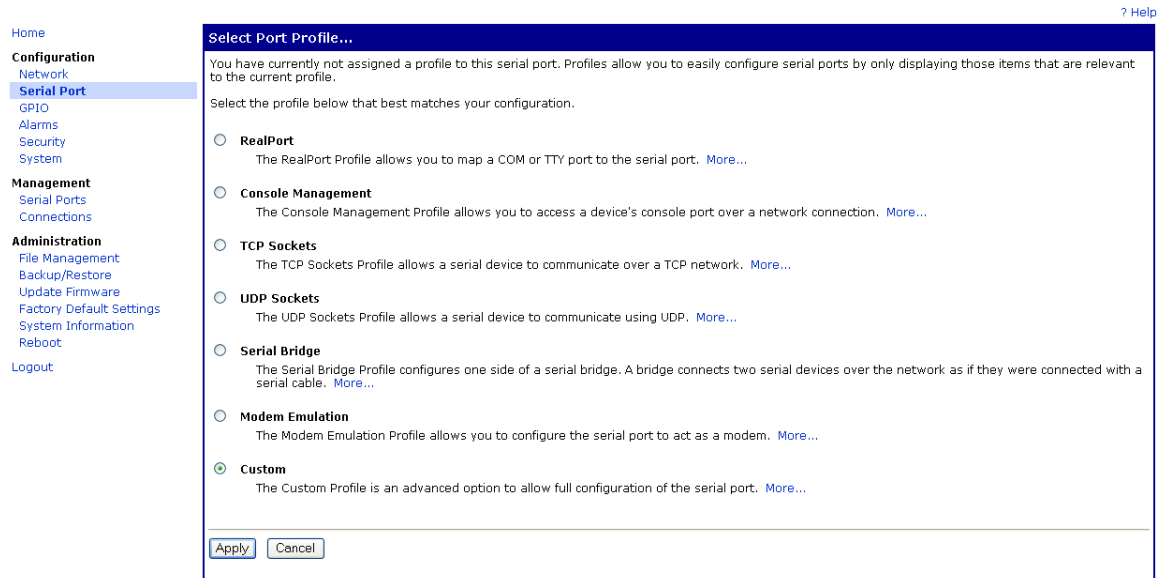

7. Click on Custom and click Apply.
8. Click on Basic Serial Settings at the bottom of the display window. You may have to scroll down to see this selection.

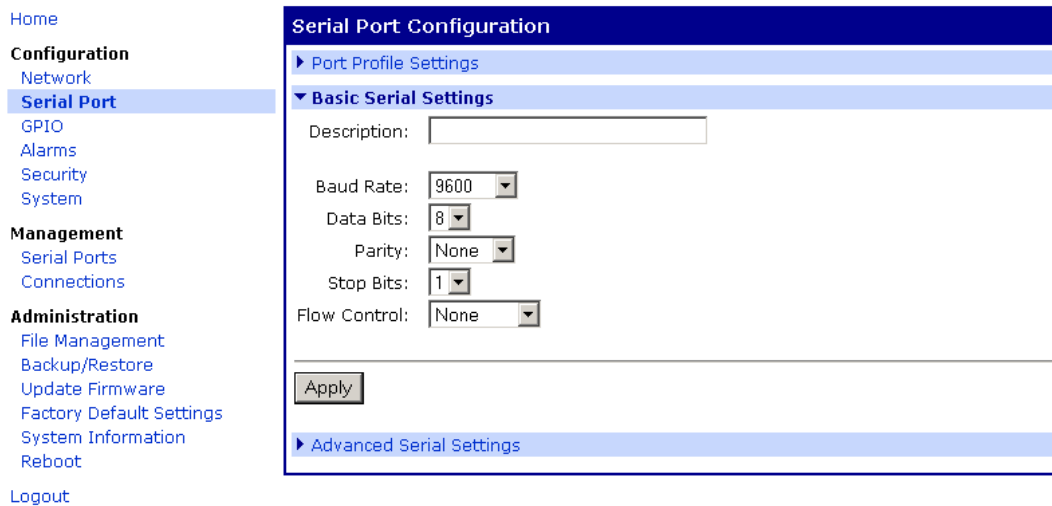

9. Change Flow Control to none and confirm the other settings are as shown above and click apply.
10. Click on Advanced Serial Settings, located just under the Apply button.

- Home
- Configuration**
- Network
- Serial Port**
- GPIO
- Alarms
- Security
- System
- Management**
- Serial Ports
- Connections
- Administration**
- File Management
- Backup/Restore
- Update Firmware
- Factory Default Settings
- System Information
- Reboot
- Logout

Serial Port Configuration

- ▶ Port Profile Settings
- ▶ Basic Serial Settings
- ▼ **Advanced Serial Settings**

Serial Settings

- Enable Port Logging
 Log Size:
- Enable RTS Toggle
 Pre-Delay: ms
 Post-Delay: ms
- Enable RCI over Serial (DSR)

TCP Settings

- Send Socket ID
 Socket ID:
- Send data only under any of the following conditions:
 - Send when data is present on the serial line
 Match string:
 - Strip match string before sending
 - Send after the following number of idle milliseconds
 ms
 - Send after the following number of bytes
 bytes
- Close connection after the following number of idle seconds
 Timeout: secs
- Close connection when DCD goes low

11. Select 'Send Data only under any of the following conditions:' by clicking on the selection check box.

12. Then select 'Send after the following number of idle milliseconds' and set the ms setting to 50.

You can now reconfigure the Wireless and Wired Ethernet Module.

Connecting to a scale through a web page

While connecting to a scale through a web page, the following window may be displayed.



Digi Connect Wi-ME Configuration and Management

[? Help](#)

Login

Welcome to the Configuration and Management interface of the Digi Connect Wi-ME

Please specify the username and password to login to the web interface.

See the User Guide and documentation for more information on logging in or retrieving a lost password.

Username:

Password:

Type the following to login to the scale:

Username: **root**

Password: **dbps**

USB Option

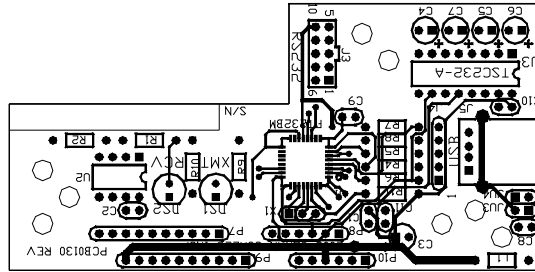

Fig. 26: USB option board

USB Windows Drivers

Virtual COM port (VCP) drivers cause the USB device to appear as an additional COM port available to the PC. Application software can access the USB device in the same way as it would access a standard COM port.

Web page link for latest software drivers: <http://www.ftdichip.com/Drivers/VCP.htm>
Select Driver Version for Device: FT232B.

Installation For Windows XP:

1. It is highly recommended that you disconnect your computer from the Internet prior to connecting your USB scale. This will allow for the latest drivers to be installed on your system. If a connection to the Internet exists, Windows may silently install older or incompatible versions of the USB driver. To disable your connection to the Internet, unplug your Ethernet cable or perform the following procedure:
 - a) Click on **Start>Control Panel**
 - b) Double-click on **Network Connections**
 - c) Right-click on your network connection (usually "**Local Area Connection**")
 - d) Click on **Disable**
2. If earlier versions of the driver are already installed on this computer, they will need to be removed. Refer to the section **Removal For Windows XP** section below.
3. Plug in your scale and connect the USB cable between the scale and your computer. This will launch the Windows Found New Hardware Wizard. Select **Install from a list or specific location (Advanced)**. Click the **Next >** button to continue.



4. Select **Search for the best driver in these locations** and enter the path to the driver directory on the installation CD. This should be D:\ USB Drivers, where D is the driver letter of your CD ROM drive. Click the **Next >** button to proceed.

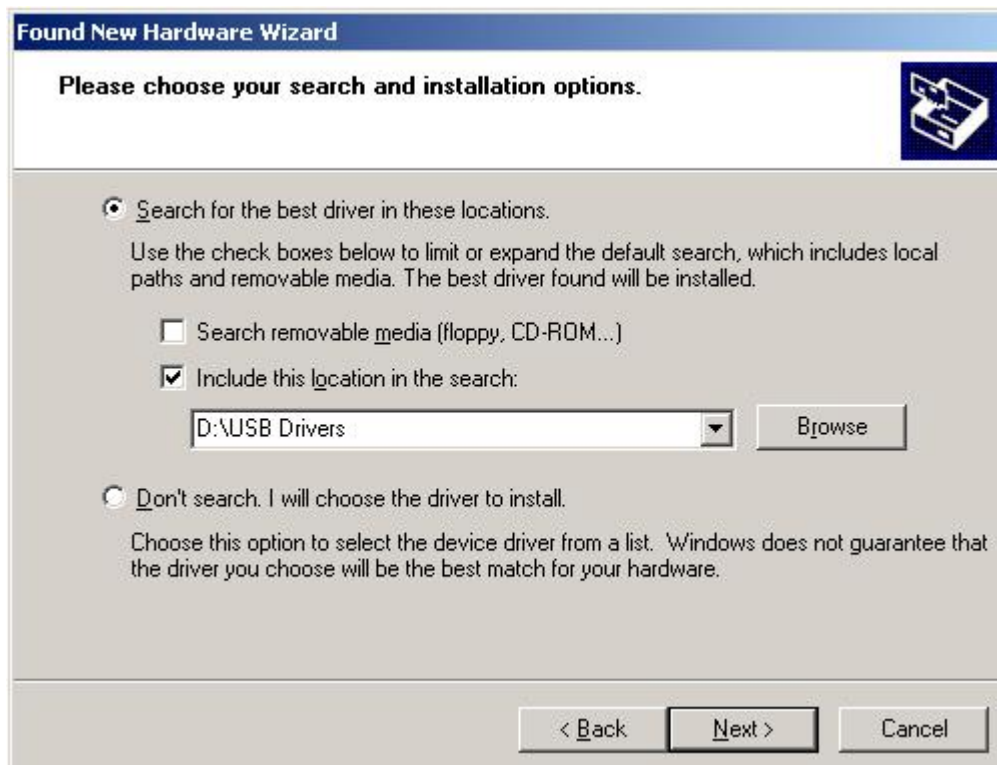

5. If a dialog appears indicating that the driver has not passed Windows Logo testing, click on **Continue Anyway**. A dialog will then appear showing the installation status while the driver is being installed. When finished, the following dialog will appear confirming the installation. Click on **Finish** to complete the installation.



6. This has installed the serial converter. Another “**Found New Hardware Wizard**” window will appear to install the COM port emulation driver. Repeat steps 4 and 5.
7. The scale will now appear as a communications (COM) port and can be accessed by any program capable of interfacing with a COM port. Doran’s Dimension and Excelerator programs are good examples, as well as Window’s HyperTerminal. To determine the currently active COM ports, perform the following procedure:
 - a) Click on **Start>Control Panel**
 - b) Double-click on **System**
 - c) Click on the **Hardware** tab at the top of the screen
 - d) Click on **Device Manager**
 - e) Click on the plus sign (+) to the left of **Ports (COM & LPT)**
 - f) A list of active COM and LPT ports will now be listed. The Doran USB COM port(s) will be listed as **USB Serial Port (COM#)**, where # is the number of the serial port.
8. If your Ethernet cable was unplugged earlier, plug it back in now. If you disabled your network connection, perform the following procedure:
 - a) Click on **Start>Control Panel**
 - b) Double-click on **Network Connections**

- c) Right-click on your network connection (usually “**Local Area Connection**”)
- d) Click on **Enable**

Removal For Windows XP:

Uninstalling drivers should be done through the **Add/Remove Programs** utility. Other methods may leave fragments of the driver that may interfere with future installations.

1. Click on **Start**.
2. Click on **Control Panel**.
3. Double-click **Add or Remove Programs**.
4. Locate the program called **FTDI USB Serial Converter Drivers** and click on **Change/Remove**.

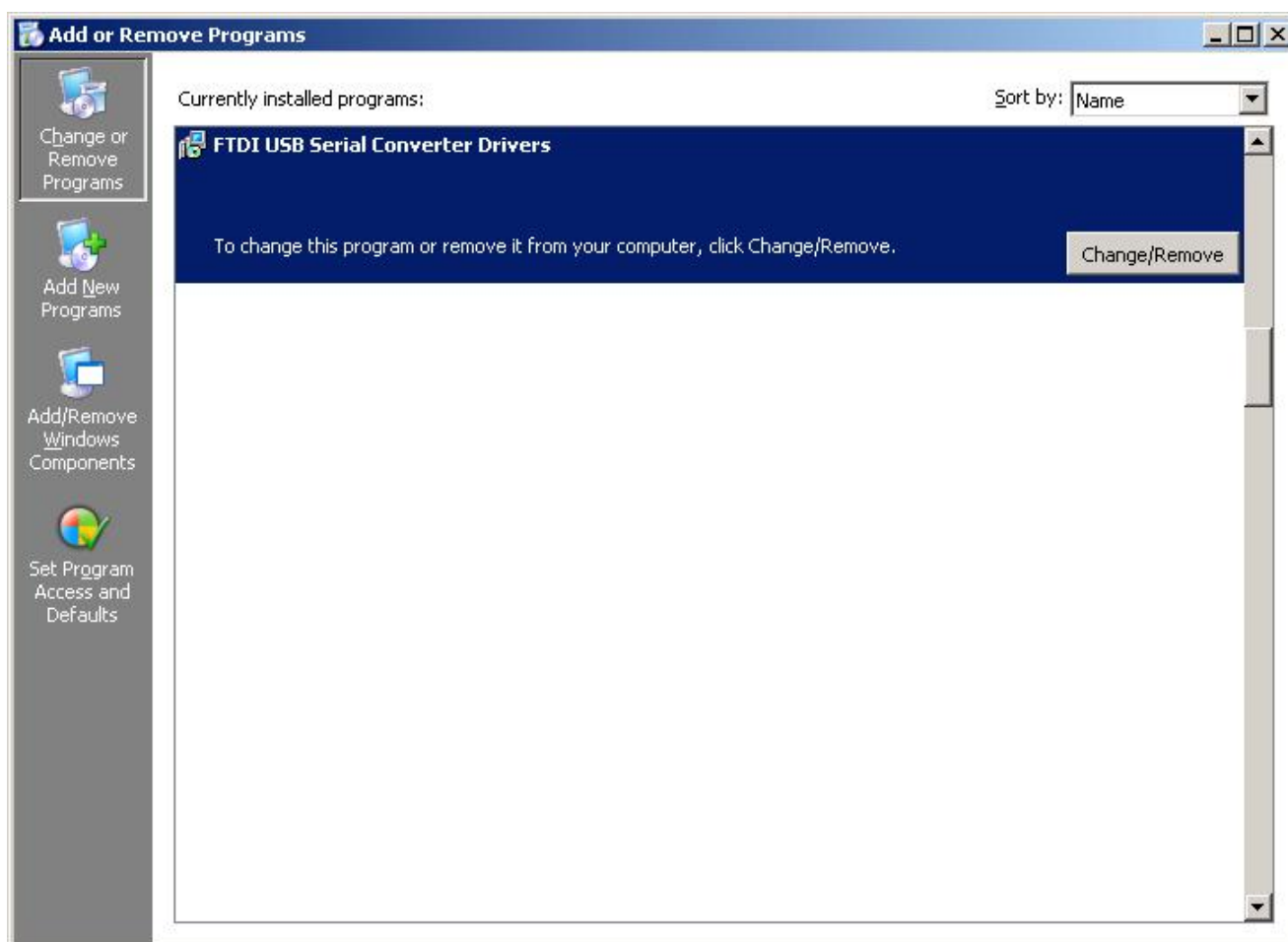

5. The following window will be displayed. Verify all scales are disconnected from the computer and click on **Continue**.



6. The drivers will be removed and the following window will be displayed. Click on **Finish** to exit.

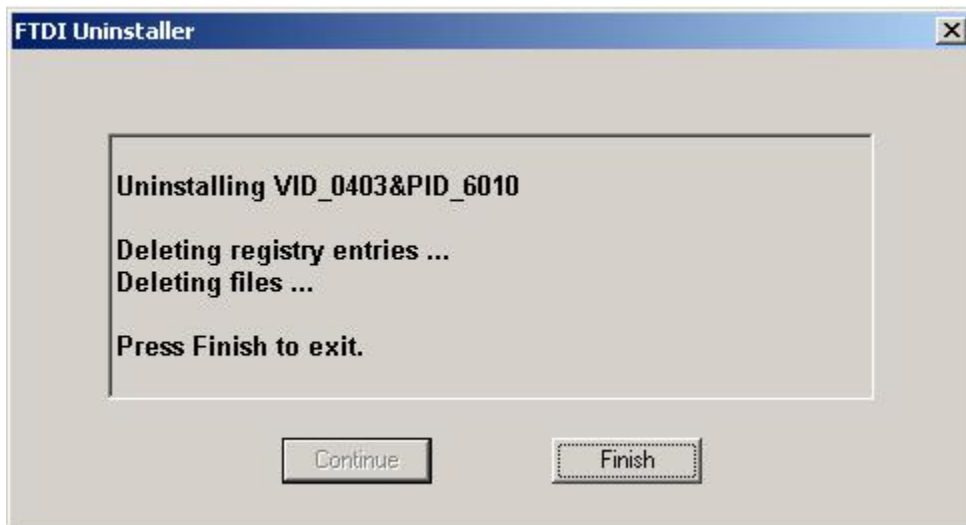

Installation For Windows 2000:

1. If earlier versions of the driver are already installed on this computer, they will need to be removed. Refer to the section **Removal For Windows 2000** section below.
2. Plug in your scale and connect the USB cable between the scale and your computer. This will launch the Windows Found New Hardware Wizard. Click on **Next >** to continue.

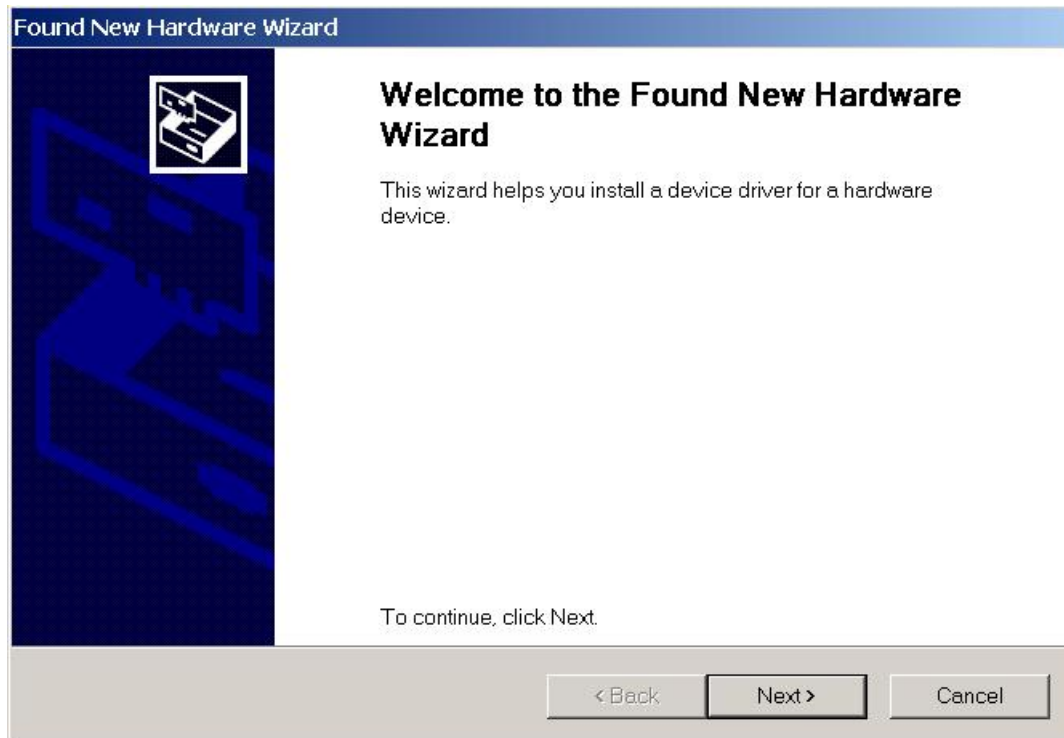

3. Select “**Search for a suitable driver for my device (recommended)**” and then click **Next >**.



4. Check the box next to “**Specify a location**” and uncheck all other boxes as shown below.

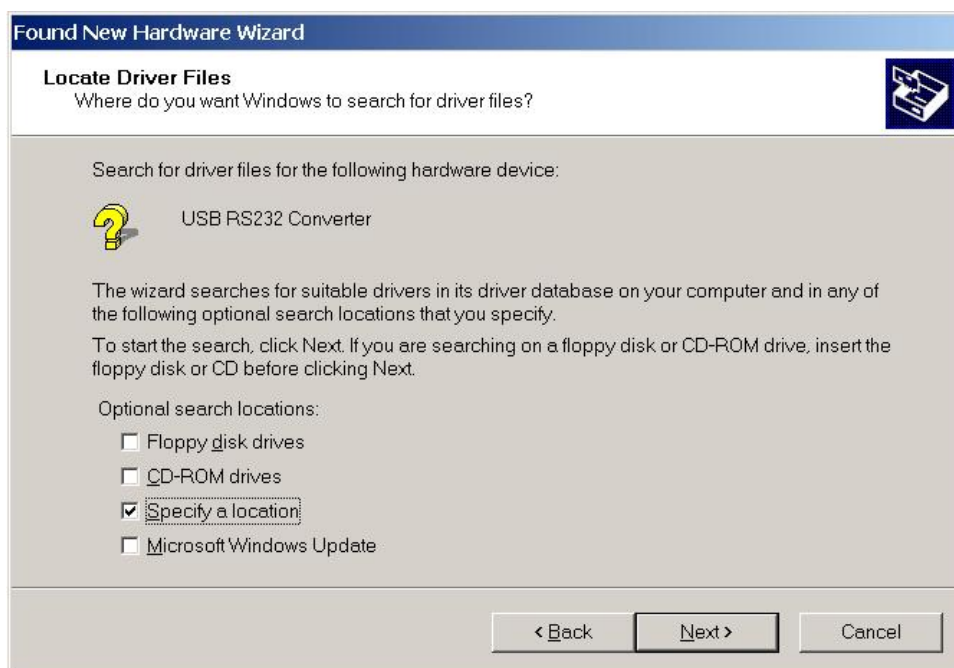

5. Clicking **Next >** displays a window asking for the location of the drivers. Enter "D:\USB Drivers" as shown below, where "D" is the driver letter of your CD ROM drive.

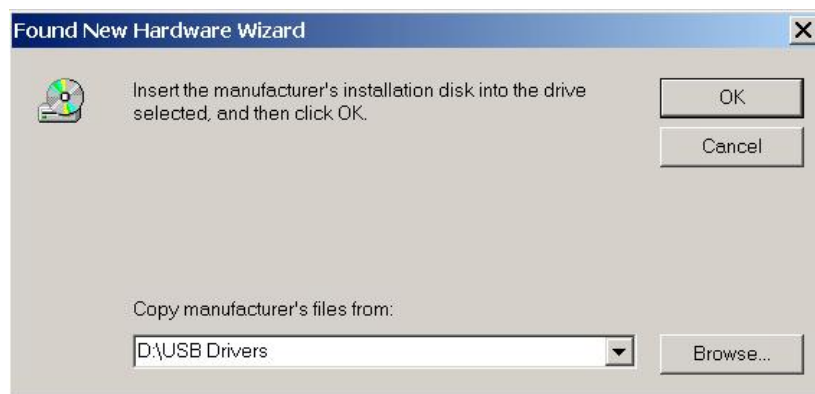

6. The following window will be displayed. Click on **Next >** to continue.

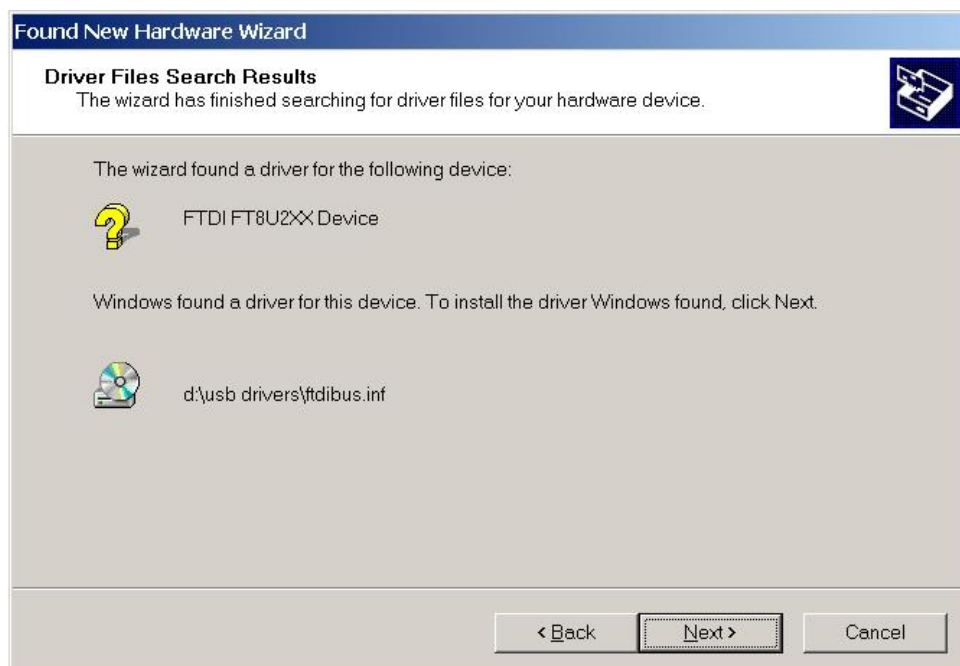

7. Windows will now begin installation. After the drivers have been installed, the following window will be displayed indicating a successful installation. Click on **Finish** to exit.



8. This has installed the serial converter. Another “**Found New Hardware Wizard**” window will appear to install the COM port emulation driver. Repeat steps 4 and 5.
9. The scale will now appear as a communications (COM) port and can be accessed by any program capable of interfacing with a COM port. Doran’s Dimension and Excelerator programs are good examples, as well as Window’s HyperTerminal. To determine the currently active COM ports, perform the following procedure:
 - a) Click on **Start>Control Panel>System**
 - b) Click on the **Hardware** tab at the top of the screen
 - c) Click on **Device Manager**
 - d) Click on the plus sign (+) to the left of **Ports (COM & LPT)**
 - e) A list of active COM and LPT ports will now be listed. The Doran USB COM port(s) will be listed as **USB Serial Port (COM#)**, where # is the number of the serial port.

Removal For Windows 2000:

Uninstalling drivers should be done through the **Add/Remove Programs** utility. Other methods may leave fragments of the driver that may interfere with future installations.

1. Click on **Start**
2. Click on **Settings**
3. Click on **Control Panel**
4. Click on **Add/Remove Programs**
5. Locate the program called **FTDI USB Serial Converter Drivers** and click on **Change/Remove**.

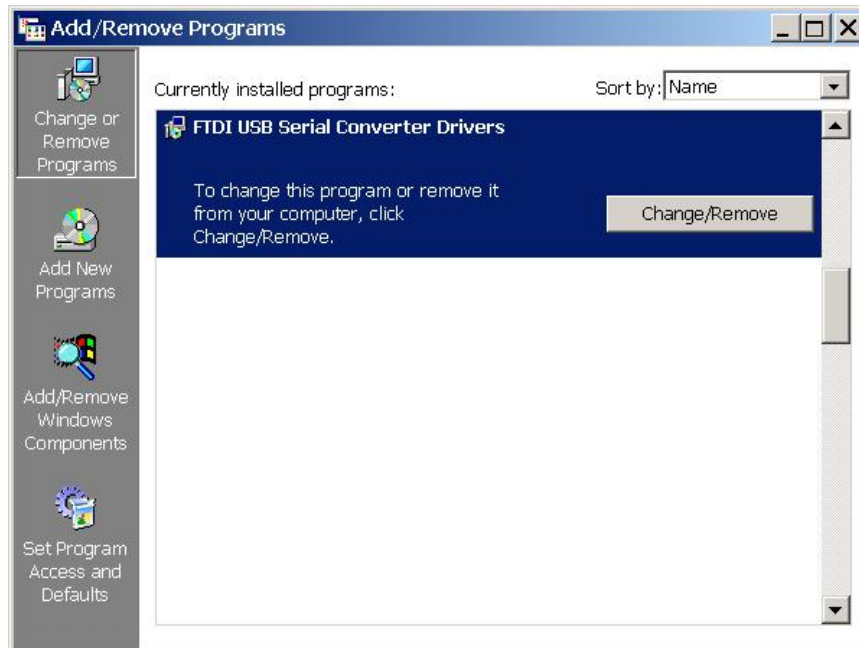

The following window will be displayed. Verify all scales are disconnected from the computer and click on **Continue**.



6. The drivers will be removed and the following window will be displayed. Click on **Finish** to exit.

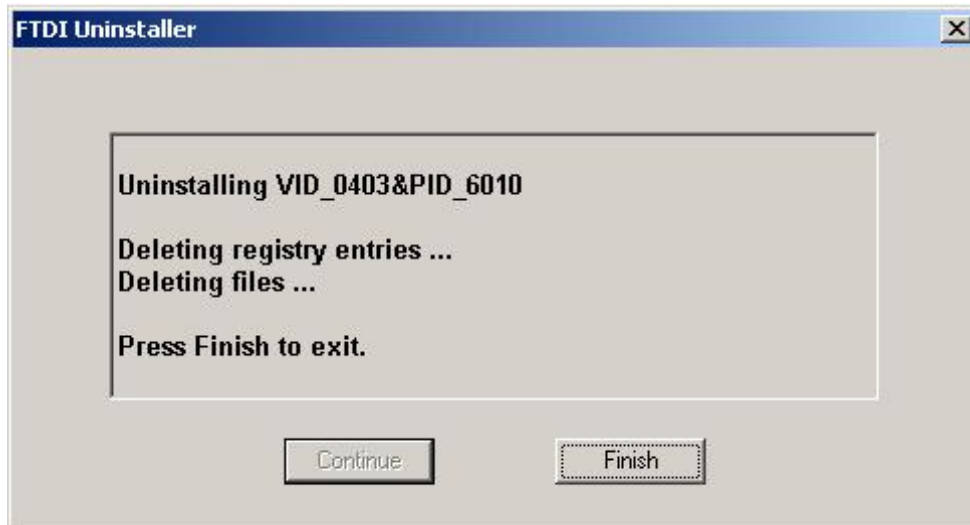

Dimension Software

Description:

The Dimension Software allows the users to view a remote scale and change parameters, setpoints, and collect data from any computer connected to the network.

Note: To enter or modify parameter values in scale's memory, the scale must be in CAL mode first.

A feature of the Dimension Software is the Live Scale Window, which emulates the operation of the Scale's display and push button functions. See figure below.

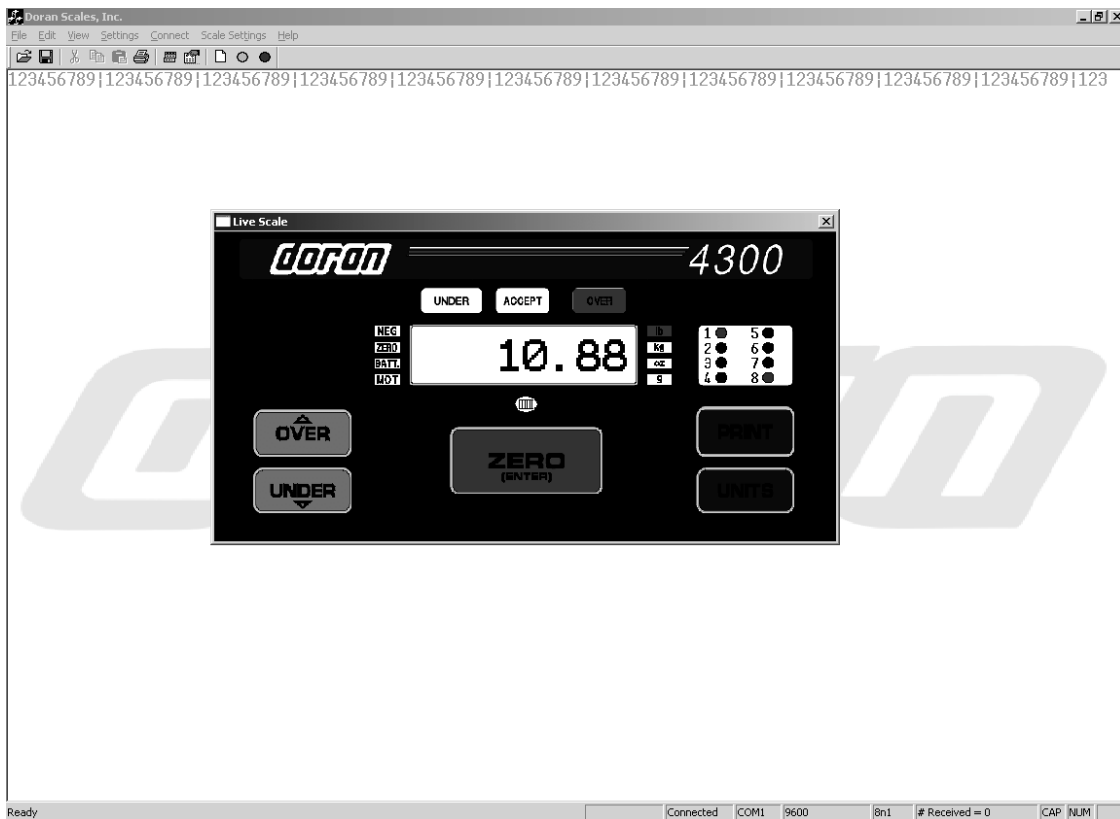

Fig. 27: Dimension Software Live Scale Window

Live Scale Configuration:

In order to be compatible with the Live Scale (Virtual) portion of the Dimension Software. The Scale's Parameters must be configured to the following settings:

- | | | | |
|------|---|--------|--|
| Av9 | = | [16 | Averaging mode set to 16 readings |
| d.o. | = | [C.P. | Data Output Mode is set to Continuous Print |
| For. | = | d3 | Data Output Format is set to Live Scale (Virtual) Display format |
| br. | = | 96 | Baud Rate is set to 9600 baud |
| HS | = | 5F | Software handshaking is active |

Troubleshooting

General problem resolution:

Problem:	What to Do or Check:
Weight reading will not repeat or scale does not return to zero when weight is removed.	Make sure that there is nothing caught in the platform under or around the load cell or spider interfering with its movement.
Scale overloads early.	Make sure all four corner overload stops are properly set, if present. Take the platter off the scale, invert it and place it back on the spider. With 1/2 of the scale's capacity in test weights concentrated over a corner of the platform, there should be approximately 1/32" of clearance between the stop and the bottom of the spider. Check all four corners then recalibrate the scale. If the problem persists, it is possible that the scale is being shock-loaded causing the load cell to be shifted.
Scale will not indicate full capacity or go into overload.	Make sure that there is nothing caught in the scale under or around the load cell or spider, which would interfere with their movement. If not, check the overload stops using the above procedure.
Scale will not come to zero when the ZERO button is pressed.	Make sure that the scale is stable ("MOT" annunciator is off) when ZERO is pressed. If excessive motion is a problem, then it may be necessary to activate the latching print feature (P04) or lengthen the filter time (R09 [32]). If the scale is stable, the scale may be set to the Canadian Legal for Trade (4% zero bandwidth). An attempt is being made to zero more than 4% of capacity (see Parameter Setup section). There may be a problem with the touch-panel or main board.
Weight readings don't seem to be correct.	Check the scale's accuracy with a test weight. Recalibrate if necessary.
Scale drifts off of zero.	Check for air currents and/or vibration around the scale. If that is the cause, it may be necessary to set the AZT aperture to a wider setting to compensate (see Parameter Setup section).
Scale drifts off of zero.	Check for air currents and/or vibration around the scale. If that is the cause, it may be necessary to set the AZT aperture to a wider setting to compensate (see Parameter Setup section).
Scale reading is bouncing or "flighty".	Check for air currents and/or vibration around the scale. If that is the cause, it may be necessary to set the Digital Averaging to a higher setting to stabilize the reading (see Parameter Setup section).

If you are still experiencing a problem with your scale, or if the problem you are having is not covered in the above list, please contact your Doran Scales authorized dealer.

Scale Messages:

Message	Meaning
"d0nE" Function complete.	The scale has successfully completed the requested action.
"Ab0rE" Aborted function.	The requested action has been canceled prior to completion.
"SARUEd" Parameter value saved.	The scale has successfully store and verified parameter value in nonvolatile memory.
"rEL P0" Release push button.	The scale has detected that a key has been depressed for more than 3 seconds.
"EnE Cd" Enter code	Enter password code, shown only when using the Front Panel CAL Access Feature.
"CLR Rc" Clear accum/counter	The Accumulator and Counter values are clear out of nonvolatile memory.
"SU nEU" New firmware installed	This message appears when the scale detects that new firmware has been loaded into flash memory.
"SEtUP" Serial Setup Mode	When the scale is connected to a computer running the Scale Setup software.

Error Messages:

Error Message	What to Do or Check:
"0ur Ld" Scale overload	The scale is in overload. The load on the scale exceeds the capacity by more than 103%. Remove excess weight from scale.
"udr Ld" Scale underload	The scale is in underload. The load on the scale is less then the minimum scale capacity by more than -20%. Recalibrate scale or add additional dead load.
"GrS 0L" Gross overload	The scale is in gross overload. The load exceeds the scale ratings and might result in damage to the scale. Remove excess weight immediately. Ignore this message for the first 5 seconds after power up.
"GrS uL" Gross underload	The scale is in gross underload. The load exceeds the minimum scale ratings and might result in damage to the scale. Loadcell connections might be wired in reverse. Ignore this message for the first five seconds after power up.
"SU 0 E" Startup zero error	The scale was not stable. <u>This error will only occur in Legal for Trade applications.</u> The scale will zero once it becomes stable.
"Er Rd" A/D failure	The scale has detected a failure in A/D circuit. Have scale serviced by a qualified scale repair technician.
"Err EP" EEPROM error	The setup parameters loaded in nonvolatile memory have become corrupted. The scale requires recalibration by a qualified scale technician.
"Err !" Program ROM error	The program memory in the scale has become corrupted. Have scale serviced by a qualified scale repair technician.

"ረፈፍ 0" Loading zero.	The scale is attempting to load power up zero. This message will remain until scale is stable.
"ንዋሽ ስ" Calibration Range Error	Calibration zero is out of range, refer to A/D Ranging section for additional information.
"ፎረ ስፎፍ" Negative Calibration Span Error	Calibration Span is negative range, Load cell signal wires backwards, refer to A/D Ranging section for additional information.
"ፎረ ስፍፍ" Motion Calibration Error	Calibration weight readings are unstable. Too much vibration during the Calibration Zero or Span. Load cell signal wires are not connected.
"ረዳ ፎረ" Calibration Span Error	Calibration Span is out of range, refer to A/D Ranging section for additional information.
"ስፍ ንዋሽ" Parameter value not saved.	The scale has <u>not</u> successfully store or verified parameter value in nonvolatile memory.
"ፎረፍ ፈፍ" Decimal Point Error.	Too many digits to the right of the decimal point have been entered for capacity.
"ፎረፍ ረፍ" Capacity Range Error.	Capacity weight entered, has more than three non-zero digits in a row.
"ፎረፍ ረፍ" Capacity weight is too low.	Capacity weight entered is less than 1 lb or kg.
"ፎረፍ 0" Capacity weight equals 0.	A zero weight has been entered for Capacity.

Resetting the scale parameters:

- If at some point the Model 7400, 4300, 7000XL, 8000XL, user wishes to return the setup parameters to factory default, follow these steps.
WARNING: Defaulting the scale will require recalibration.
- Enter Cal mode by using Cal access feature or by pressing the CAL button.
- Once in CAL menu, use the units button to scroll to menu item "ፈፎፍ ስ". Press ZERO button to select yes "ፈፎፍ ሄ". Press UNITS button to enter answer, display will show again "ፈፎፍ ስ", Press ZERO button to select yes "ፈፎፍ ሄ" and then press UNITS button, to default all parameters.
- The scale will then show " ስ ስ" and "ንዋሽፎፍ". After the "ንዋሽፎፍ" message is displayed the scale then perform its normal power up routine and enter the Calibration mode. At this time, all the parameters will have been reset to their factory default settings. See Setup Menus Explained section for details on setting up the individual scale parameters.
- Return to the normal weighing position by scrolling to the end of the menu "ፈፍፍ ሄ" or press CAL push button again. The scale will save the revised parameters and will enter the normal weighing mode.

Note: A second method to default parameter settings is by holding the CAL push button while powering up scale. The indicator will display "ረፎፍ ፍፍ" until the CAL button is released, then show " ስ ስ" and "ንዋሽፎፍ".

Resetting the scale:

In the event that a power problem has disabled the scale, remove power, wait 15 seconds and restore power. The scale should restart and function properly.



UPS Application Note

UPS On-Line WorldShip Software Rev 3.1 and Higher

Description:

The following instructions will allow a Scale to be connected to the UPS On-Line shipping system. The UPS On-Line software operates by continuously polling the scale for weight several times a second. The program then displays the current weight in a window marked "Scale Weight:". This package weight, in pounds is then used to generate a shipping label if the "Electronic Scale Activated" check box is selected.

Hardware Setup:

Before starting the UPS On-Line software, connect the Scale's serial port to the computer's serial port (com1 or com2) by way of a optional serial cable. Apply power to the scale and press the ZERO push button.

WARNING: The scale must be on and connected at all times while the UPS On-Line program is running. If the scale is disconnected, turned off, or placed in the calibration mode, an error message will be displayed on the computer screen. To correct this error, you must perform a scale setup again or restart the UPS software – see Software Setup for instructions.

Software Setup:

Computer: If the UPS On-Line program has been already installed, follow the configuration steps below only. If the UPS On-Line program is not installed, power up the scale and connect the scale's serial cable to an available PC serial port. Next, install the UPS On-Line program as per instruction on the UPS installation CD. The installation program will prompt you to select if a scale is connected, select yes.

To configure the UPS On-Line WorldShip program:

- 1) Click on the "Tools" menu located at top of screen, then select "System Preferences".
- 2) Click on the "Hardware" tab and set the "Scale Type:" drop down menu to "Fairbanks 70-2453-4".
- 3) Click on the "Scale Port:" drop down menu, choose which serial port the scale is connected to, com1 or com2. This is the port that the DB9 cable is connected to at the rear of your PC from the scale.
- 4) Finally, click on the "Test Scale" button. Place weight on the scale. The computer should then display the current weight on the scale.
- 5) Click the "OK" button, and return back to the service menu.
- 6) Check the "Electronic Scale Activation" box to accept weight readings from the scale. The current weight will be displayed under the "Package:" section, in the "Scale Weight" window. NOTE: UPS software does not show zero or negative weights on the main display page.

Scale Configuration:

In order to be compatible with the UPS On-Line program. The Scale's Parameters must be configured to the following settings:

avg	= 08	Averaging mode set to 8 readings
d.o.	= t.o.d.	Data Output Mode is set to Transmit On Demand
for.	= UPS	Data Output Format is set to UPS protocol
br.	= 96	Baud Rate is set to 9600 baud
units	= lb	Start up units must be set to pounds
HS	= SF	Software handshaking is active

These parameters are set by entering the scale setup mode. A Doran qualified scale distributor should only do this, as entering the scale setup mode can affect the accuracy of your scale.

Troubleshooting:

If any problems occur with your UPS On-Line Software, a trouble-shooting guide can be found on the United Parcel Service web site under Shipping Systems Scales at address:

<http://www.ups.com/using/custserv/techfaq/scales.html>

Or alternatively, contact Doran Scale's Technical Support Department at 800-262-6844 for assistance over the phone.

Grading Products Application Note

Grade and show product weight (95t):

The following instructions will configure the scale to display for 2 seconds a product's weight when removed from or added to a container. The product weight is determined from the difference between two stable weights. If the scale becomes unstable and then stable again before the 2 second hold timer has finished, the new weight difference is displayed. All Checkweigh or Setpoint functions are only active during the 2 second hold period. (see Checkweigh and Setpoint Operation Section). By using the Accumulator and Counter feature, the number of products and total weight can be stored. To activate the Accumulator and Counter feature, set the Printer Data Output "d.o." parameter to Auto Print 2 "R.P.2" (see Accumulator / Counter Operation Section). Another scale feature that can be utilized is the Digital Output board option, which can be configured to indicate up to eight grades by way of lights or beepers (see Digital Output Board option for more details).

Scale Configuration:

In order to setup the scale to operate in a grade and show product weight application. The Scale's Parameters must be configured to the following settings:

o.P.	= 95t.	Operation mode is set to Grading and show product weight.
Avg	= 8	Averaging mode set to 8 readings
m.A.	= 0.5	Motion Aperture is set to 0.5 divisions
C.o.	= 5EA	Check Weighing Operation is set to Setpoint operation mode.

Grade and show grade number (9nt):

When a product's weight is removed from or added to a container. The scale will display for 2 seconds, the current grade number (i.e. "111111" to "888888"). The grade number is determined by comparing each setpoint level with the product weight. If the product weight lies between two setpoint levels, the grade number would be the lower numerical setpoint number. For example, the product weight is 10 lbs., setpoint 3 is 9 lbs. and setpoint 4 is 12 lbs. The grade number shown on the display would be 3 or "333333", where SP 3 >= grade < SP 4. The setpoint testing sequence starts with the high to low setpoint number, i.e. weight >= setpoint 8 then weight >= setpoint 7 and so on. The product weight is calculated from the difference between two stable weights. If the scale becomes unstable and then stable again before the 2 second hold timer has finished, a new setpoint number is displayed. Output functions are only active during the 2 second hold period. (see Setpoint Operation Section). By using the Accumulator and Counter feature, the number of products and total weight can be stored. To activate the Accumulator and Counter feature, set the Printer Data Output "d.o." parameter to Auto Print 2 "R.P.2" (see Accumulator / Counter Operation Section). Another scale feature that can be utilized is the Digital Output board option, which can be configured to indicate up to eight grades by way of lights or beepers (see Digital Output Board option for more details).

Scale Configuration:

In order to setup the scale to operate in a grade and show grade number application. The Scale's Parameters must be configured to the following settings:

o.P.	= 9nt.	Operation mode is set to Grade and show setpoint number.
Av9	= 08	Averaging mode set to 8 readings
nn.R.	= 0.5	Motion Aperture is set to 0.5 divisions
C.o.	= 5EA	Check Weighing Operation is set to Setpoint operation mode.

Replacement Part List

SUB0568	<u>7000XL Main PCB Assembly kit, 115 VAC (Excel series).</u>
SUB0568-1	<u>7000XL Main PCB Assembly, 230 VAC (Excel series).</u>
SUB0569	<u>8000XL Main PCB Assembly kit, 115 VAC (Excel series).</u>
SUB0569-1	<u>8000XL Main PCB Assembly, 230 VAC (Excel series).</u>
SUB0570	<u>4300 / 7400 Main PCB Assembly kit, 115 VAC (Excel series).</u>
SUB0570-1	<u>4300 / 7400 Main PCB Assembly, 230 VAC (Excel series).</u>
SUB0571	<u>4300 Main PCB (Battery) Assembly kit, 115 VAC (Excel series).</u>
PCA0278	<u>7400 / 4300 Main PCB (non-Battery) Assembly, 115 VAC.</u>
PCA0277	<u>4300 Main PCB (Battery) Assembly, 115 VAC.</u>
PCA0287	<u>7000XL Main PCB Assembly, 115 VAC (Excel series).</u>
PCA0288	<u>8000XL Main PCB Assembly, 115 VAC (Excel series).</u>
SUB0513	<u>7400 Zero Switch Assembly</u> Pushbutton switch with cable, & PCB connector
SUB0013-1	<u>7400 Zero Switch Assembly 3 Pack</u> 1 set of 3 P/N SUB0013D with S/S Boot
SUB0514	<u>7400 Zero & Units Switch Assembly</u> 2 pushbutton switches with cables, UNITS label & connectors
SWI0122	<u>Stainless Steel Pushbutton</u>
SUB0566	<u>4300 EXCEL Touch Panel Assembly</u> Includes overlay, switch assembly, and installation instructions
SUB0567	<u>4300 EXCEL Face Plate Only</u> Includes face plate and instructions
SUB0427	<u>7000XL Touch Panel Assembly</u> Includes overlay, switch assembly, and installation instructions
SUB0439	<u>7000XL Face Plate Only</u> Includes face plate and instructions

SUB0395	<u>8000XL Touch Panel Assembly</u> Includes overlay, switch assembly, and installation instructions
SUB0396	<u>8000XL Face Plate Only</u> Includes face plate and instructions
SWI0104-B	<u>7000XL / 8000XL Inner Switch Assembly</u>
SWI0128-B	<u>4300 EXCEL Inner Switch Assembly</u>
SUB0004-1	<u>Foot Assembly Set</u> Rubber feet; S/S 10-24 x 1 screw, sold in sets of 6 only
HDW0042	<u>S/S Foot</u> Sold singly, for 18"x18" & larger bases, 1/2-20 NF Thread
SUB0063-1	<u>Power Cord</u> Shielded, 8 ft long, 18/3 SJEOW, with chosorb, connector, assembly, and instruction sheet.
CNT0019	<u>Liquid-Tite Feed Thru</u> For load cell, power cord & option inputs
SUB0399	<u>Sealing Plug Kit</u>
LBL0173-A	<u>Capacity Labels</u>
FUS0019	<u>Fuse, 1/4 Amp, Slo-Blo Non-Battery (115VAC), Battery (230VAC)</u>
FUS0020	<u>Fuse, 1/2 Amp, Slo-Blo Battery (115VAC)</u>
FUS0021	<u>Fuse, 1/18 Amp, Slo-Blo Non-Battery (230VAC)</u>
SUB0038-4	<u>4300 / 8000XL Battery</u> 4 Ah, 6 Volt, lead acid, rechargeable, with terminals, and wires
ENC0585	<u>4300 / 8000XL Battery Bracket</u>
LEN0041	<u>7400 Lens Replacement Kit</u> lens only, requires SHP0026, RTV adhesive
SHP0026	<u>RTV adhesive, DC732</u>
SUB0438	<u>Non-Battery Gasket & Screw Set, Rear Panel</u> 3 standard, 1 cross-drilled 10-32 bolts, 4 rubber bonded metal washers and 1 rear gasket.

SUB0398	<u>Battery Gasket & Screw Set, Rear Panel</u> 3 standard, 1 cross-drilled 10-32 bolts, 4 rubber bonded metal washers and 1 rear gasket.
GSK0024	<u>Rubber Gasket, Rear Panel</u>
SUB0455	<u>E Mounting Brackets-</u> Connects Base to Indicator, same as Option E. If the scale base does have drilled and tapped holes on the side, this part MUST be used.
SUB0417	<u>Kit, 14" Atlas Column with Hardware</u>
SUB0425	<u>Kit, 20" Atlas Column with Hardware</u>
SUB0426	<u>Kit, 30" Atlas Column with Hardware</u>
MAN0245	<u>7400 Operator User Manual</u>
MAN0192	<u>7000X Operator User Manual</u>
MAN0191	<u>8000XL Operator User Manual</u>
MAN0239	<u>EXCEL Instruction Manual</u>
SUB0574 (Specify Capacity)	<u>7400 Case Cover Assembly</u> With lens & zero S/S push button
SUB0441	<u>7000XL Case Cover Assembly</u> With touch panel (backplate not included)
SUB0397	<u>8000XL Case Cover Assembly</u> Touch panel included (Includes both SWI104-B & SWI105)
HDW0011	<u>Bubble Level</u>
ENC0624	<u>"U" Bracket</u> Tilt Stand bracket for case
ENC0604	<u>7400 / 4300 / 7000XL Backplate</u> Rear cover, (non-battery, non-internal relay)
ENC0586	<u>8000XL Backplate</u> Rear cover with cord wrap bracket (w/o battery bracket or battery)
SUB0210-1	<u>Knob, "U" Bracket Adjust</u> Adjustment knob with washer
SUB0041-1	<u>Foot Switch</u> Non wash down, cable included

SUB0442	<u>Calibration/Units Switch Replacement Kit</u>
IND0006	<u>Power Cord Chosorb</u>
MSC0085	<u>7400 / 4300 / 7000XL Scale Veil</u>
MSC0102	<u>8000XL / 4300(battery) Scale Veil</u>
MSC0150	<u>+5V Power Supply for External Relay Box</u>
CAP0054	<u>Quencharc for Relay output terminal</u>
RLY0027	<u>5 Volt Mechanical Relay (obsolete)</u> OMRON#G2R-1S-DC5(S), 10A 250VAC / 30VDC
RLY0028	<u>AC Solid State Relay</u> OMRON#G3R-OA202SZN-AC524, 2A 100-240VAC
RLY0029	<u>DC Solid State Relay</u> OMRON #G3R-ODX02SN-DC524, 2A 5-48VDC
RLY0033	<u>6 Volt Mechanical Relay</u> OMRON#G2R-1S-DC6(S), 10A 250VAC / 30VDC
MSC0153	<u>OVER BEEPER - Continuous</u>
MSC0154	<u>ACCEPT BEEPER - Chime</u>
MSC0155	<u>UNDER BEEPER - Warble</u>

Scale Option List

EXOPT100	<u>Option, Analog 4-20mA Output (Passive & Active)</u>
EXOPT101	<u>Option, Wired Ethernet Network, RJ45</u>
EXOPT102	<u>Option, Wireless Ethernet Network (802.11b)</u>
EXOPT103	<u>Option, Fiber Optic Interface</u>
EXOPT104	<u>Option, Digital Output, with 6' cable</u>
EXOPT105	<u>Option, RS-485 Interface, 10' with pigtails</u>
EXOPT106	<u>Option, Internal 4 Slot Relays (no relays)</u>
EXOPT107	<u>Option, External Relay Box, DIN Rail (no relays)</u>
EXOPT108	<u>Option, Internal Mechanical Relay, 10A 250VAC/30VDC</u>
EXOPT109	<u>Option, Internal Solid State Relay, 2A 100-240VAC</u>
EXOPT110	<u>Option, Internal Solid State Relay, 2A 5-48VDC</u>
EXOPT111	<u>Option, Mechanical Relay DIN Module, 10A 250VAC/30VDC</u>
EXOPT112	<u>Option, Solid State Relay DIN Module, 2A 100-240VAC</u>
EXOPT113	<u>Option, Solid State Relay DIN Module, 2A 5-48VDC</u>
EXOPT114	<u>Option, 6-digit Remote Display, 0.56"</u>
EXOPT115	<u>Option, Remote Zero Switch (IP20 non washdown)</u>
EXOPT116	<u>Option, Remote Print Switch (IP20 non washdown)</u>
EXOPT117	<u>Option, Remote Units Switch (IP20 non washdown)</u>
EXOPT118	<u>Option, RS232 Serial Cable, 10 ft., Pigtail ends.</u>
EXOPT119	<u>Option, RS232 Serial Cable, 10 ft., DB9(F) SW HND SHK.</u>
EXOPT121	<u>Option, RS232 Serial Cable, 10 ft., DB25(F) SW HND SHK.</u>
EXOPT123	<u>Option, 230 VAC operation (non-battery)</u>
EXOPT124	<u>Option, 230 VAC operation (battery)</u>

EXOPT134	<u>Option, Upgrade from 20" to 30" Atlas Column</u>
EXOPT136	<u>Option, Stainless Steel Load Cell for 10" x 10" base</u>
EXOPT137	<u>Option, Stainless Steel Load Cell for 12" x 12" base</u>
EXOPT138	<u>Option, Stainless Steel Load Cell for 15" x 15" base</u>
EXOPT139	<u>Option, Quick disconnect Loadcell cable</u>
EXOPT141	<u>Option, Quick disconnect Remote switch</u>
EXOPT142	<u>Option, Quick disconnect both Loadcell cable & Remote SW</u>
EXOPT147	<u>Option, External D.C power</u>
EXOPT148	<u>Option, RS232 Serial Cable, 10 ft., DB9(M) SW HNDSHK.</u>
EXOPT149	<u>Option, 4300 Battery</u>
EXOPT150	<u>Option, Washdown Ethernet RJ45 male connector</u>
EXOPT151	<u>Option, 1st Internal Beeper, Accept (Chime)</u>
EXOPT152	<u>Option, 1st Internal Beeper, Over (Continuous)</u>
EXOPT153	<u>Option, 1st Internal Beeper, Under (Warble)</u>
EXOPT154	<u>Option, Additional Beeper, Accept (Chime)</u>
EXOPT155	<u>Option, Additional Beeper, Over (Continuous)</u>
EXOPT156	<u>Option, Additional Beeper, Under (Warble)</u>
EXOPT157	<u>Option, 1st External Beeper, Accept (Chime)</u>
EXOPT158	<u>Option, 1st External Beeper, Over (Continuous)</u>
EXOPT159	<u>Option, 1st External Beeper, Under (Warble)</u>
EXOPT160	<u>Option, Washdown USB Interface</u>
EXOPT161	<u>Option, 14" Atlas Column</u>
EXOPT162	<u>Option, USB Waterproof Cable Type A, 3 ft.</u>
EXOPT163	<u>Option, USB Waterproof Cable Type A, 15 ft.</u>
EXOPT165	<u>Option, Remote Zero Switch (IP68 washdown)</u>

EXOPT166 Option, Remote Print Switch (IP68 washdown)

EXOPT167 Option, Remote Units Switch (IP68 washdown)